

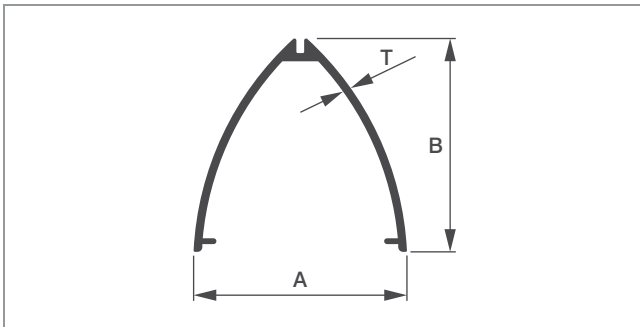

CUP PLATES

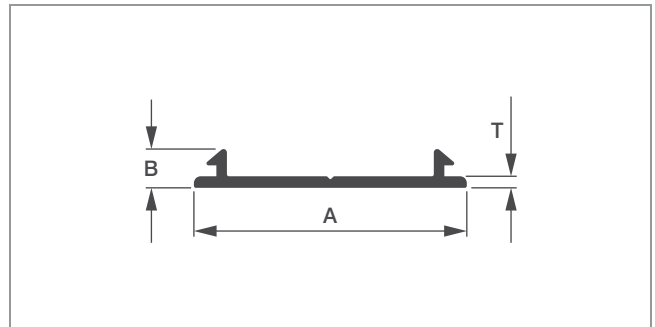

Sl. No.	Sec. No.	A	B	T	Wt. Range KG/12'
1	7247	44.00	44.00	1.70	1.800 - 2.000



Sl. No.	Sec. No.	A	B	T	Wt. Range KG/12'
1	7248	40.10	5.70	1.70	0.800 - 0.900

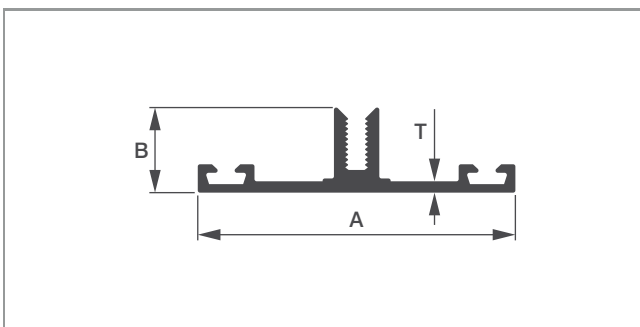

Sl. No.	Sec. No.	A	B	T	Wt. Range KG/12'
1	4201	56.00	15.00	2.00	1.965 - 2.180

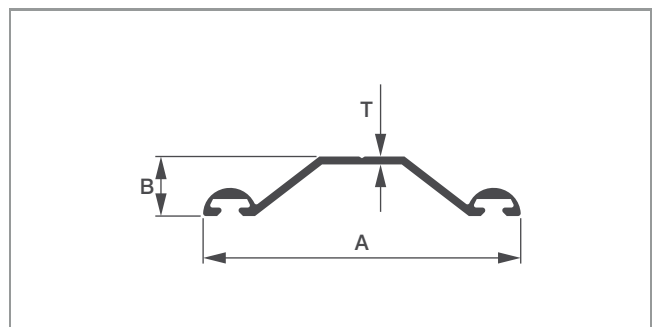

Sl. No.	Sec. No.	A	B	T	Wt. Range KG/12'
1	4202	56.00	10.50	1.40	1.000 - 1.200

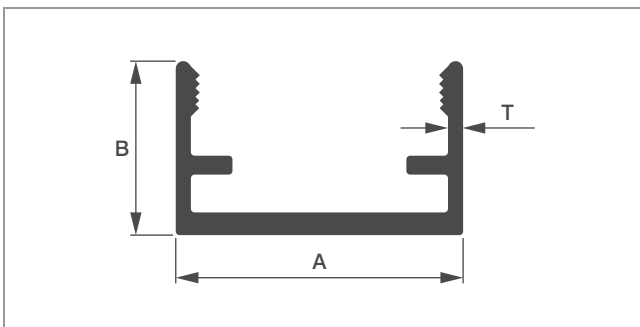

Sl. No.	Sec. No.	A	B	T	Wt. Range KG/12'
1	1669	38.00	23.00	2.00	2.200 - 2.750

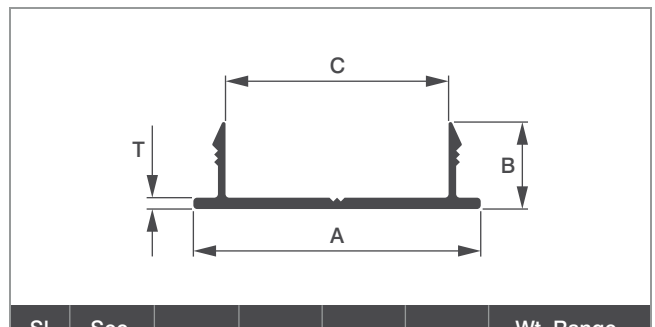

Sl. No.	Sec. No.	A	B	C	T	Wt. Range KG/12'
1	1670	38.00	11.50	29.50	1.50	0.700 - 1.000

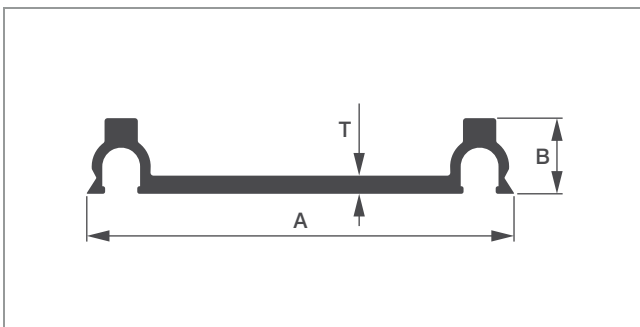

Sl. No.	Sec. No.	A	B	T	Wt. Range KG/12'
1	1661	56.50	10.00	2.40	1.650 - 1.800

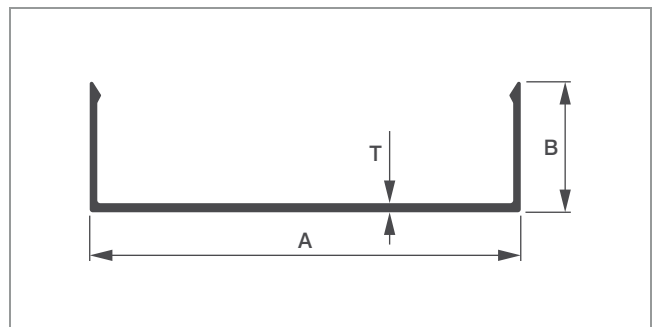

Sl. No.	Sec. No.	A	B	T	Wt. Range KG/12'
1	1662	57.00	17.25	1.20	1.000 - 1.200



CUP PLATES



Sl. No.	Sec. No.	A	B	T	Wt. Range KG/12'
1	7237	97.97	10.00	2.00	2.300 - 2.500

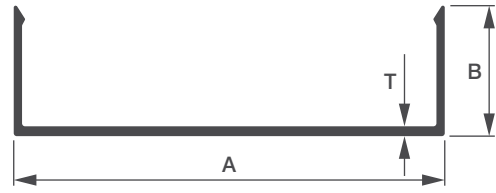

Sl. No.	Sec. No.	A	B	T	Wt. Range KG/12'
1	7238	100.00	25.00	1.30	1.900 - 2.100

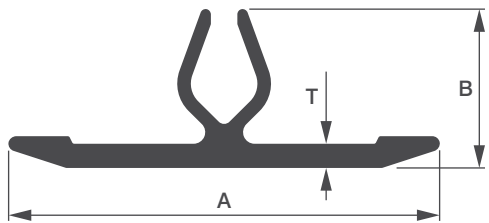

Sl. No.	Sec. No.	A	B	T	Wt. Range KG/12'
1	5324	57.00	21.00	3.20	2.500 - 2.700

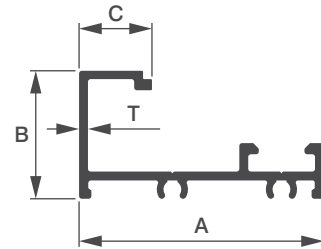

Sl. No.	Sec. No.	A	B	C	T	Wt. Range KG/12'
1	5325	44.00	23.00	13.10	1.60	1.700 - 1.900

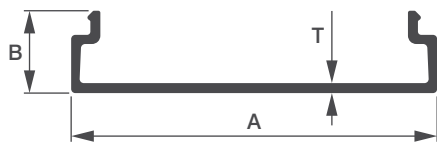

Sl. No.	Sec. No.	A	B	T	Wt. Range KG/12'
1	5326	44.00	9.90	1.20	0.750 - 0.820

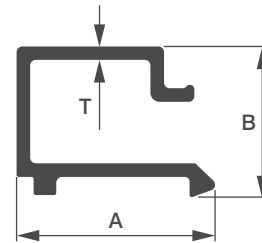

Sl. No.	Sec. No.	A	B	T	Wt. Range KG/12'
1	5327	17.50	13.28	1.18	0.580 - 0.630



Sl. No.	Sec. No.	A	B	T	Wt. Range KG/12'
1	5490	27.50	6.60	1.50	0.550 - 0.850

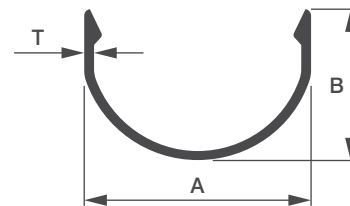

Sl. No.	Sec. No.	A	B	T	Wt. Range KG/12'
1	5491	30.00	20.00	1.30	0.560 - 0.960



CUP PLATES

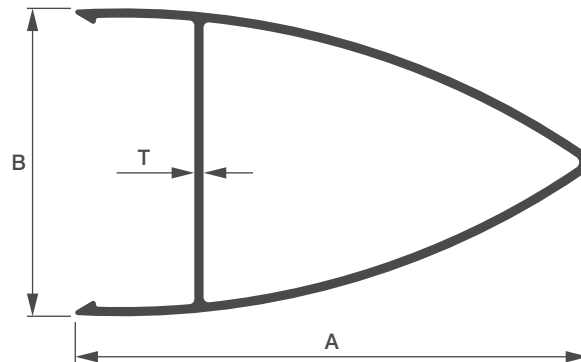

Sl. No.	Sec. No.	A	B	T	Wt. Range KG/12'
1	5333	100.00	60.00	1.80	4.700 - 5.100

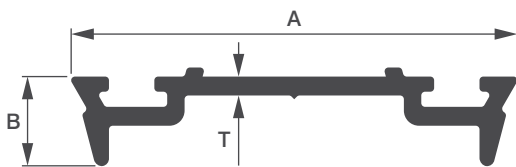

Sl. No.	Sec. No.	A	B	T	Wt. Range KG/12'
1	5332	59.00	11.80	2.50	2.200 - 2.400

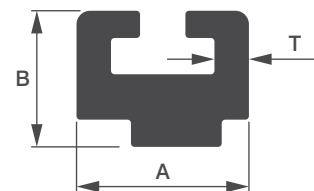

Sl. No.	Sec. No.	A	B	T	Wt. Range KG/12'
1	5336	19.00	15.00	3.80	1.900 - 2.100

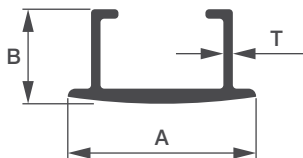

Sl. No.	Sec. No.	A	B	T	Wt. Range KG/12'
1	5337	24.90	12.50	1.25	0.720 - 0.790



Sl. No.	Sec. No.	A	B	Wt. Range KG/12'
1	5338	27.00	9.50	1.900 - 2.100

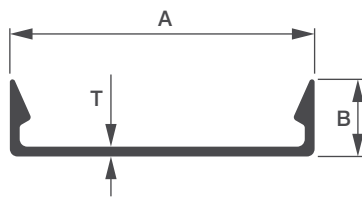

Sl. No.	Sec. No.	A	B	T	Wt. Range KG/12'
1	5340	40.30	10.20	1.30	0.800 - 0.900

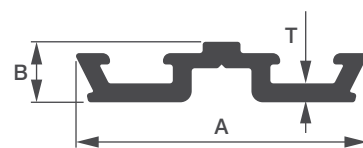

Sl. No.	Sec. No.	A	B	T	Wt. Range KG/12'
1	5341	38.50	8.00	2.50	1.300 - 1.500



CUP PLATES

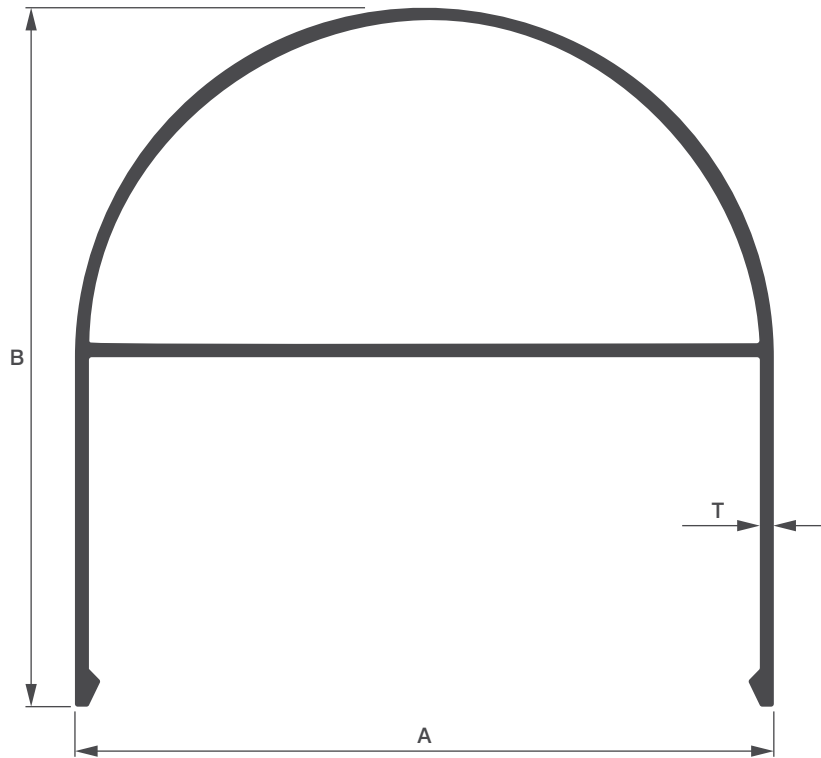

Sl. No.	Sec. No.	A	B	T	Wt. Range KG/12'
1	5330	100.00	100.00	2.00	7.000 - 7.400

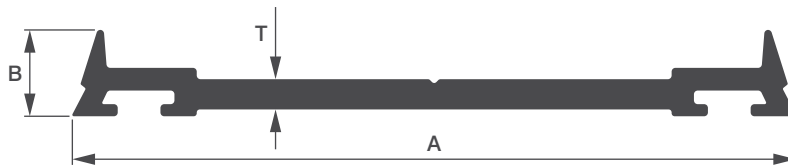

Sl. No.	Sec. No.	A	B	T	Wt. Range KG/12'
1	5331	95.70	11.40	4.00	4.000 - 4.400

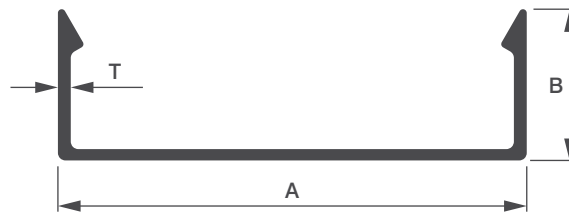

Sl. No.	Sec. No.	A	B	T	Wt. Range KG/12'
1	5306	62.00	20.00	1.70	1.600 - 1.800



CUP PLATES

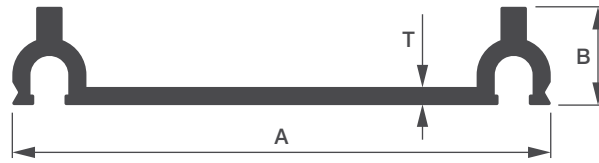

Sl. No.	Sec. No.	A	B	T	Wt. Range KG/12'
1	5364	71.20	13.00	2.40	2.400 - 2.900

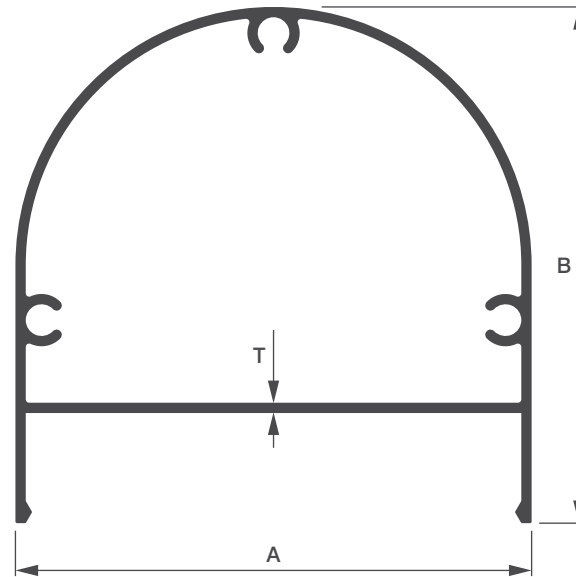

Sl. No.	Sec. No.	A	B	T	Wt. Range KG/12'
1	5365	75.00	75.00	1.50	4.400 - 4.950

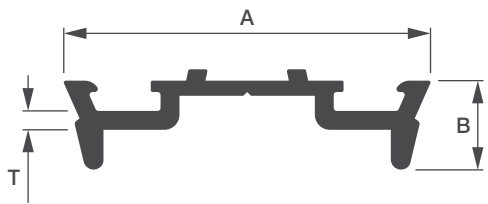

Sl. No.	Sec. No.	A	B	T	Wt. Range KG/12'
1	5367	48.50	11.80	2.50	1.800 - 2.400



Sl. No.	Sec. No.	A	B	T	Wt. Range KG/12'
1	5366	50.00	20.00	1.30	1.150 - 1.750

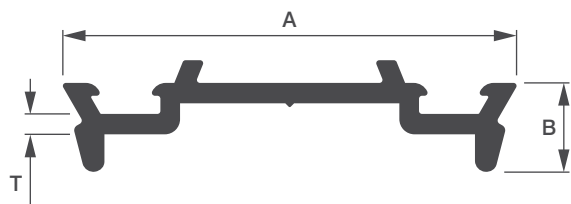

Sl. No.	Sec. No.	A	B	T	Wt. Range KG/12'
1	5369	60.00	11.80	2.70	2.450 - 2.950

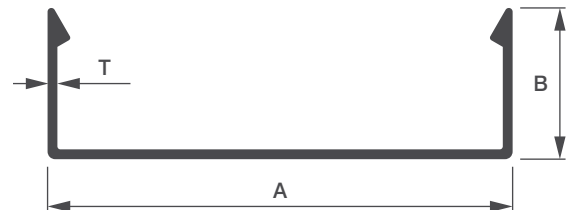

Sl. No.	Sec. No.	A	B	T	Wt. Range KG/12'
1	5368	61.50	20.00	1.30	1.300 - 1.800



CUP PLATES

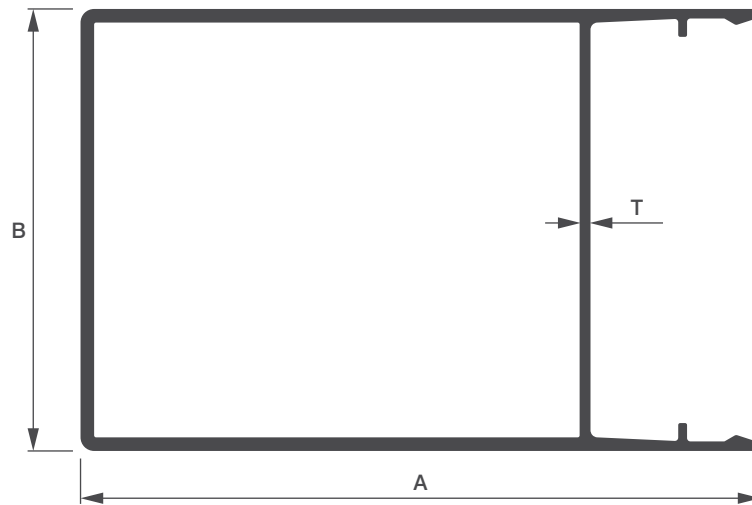

Sl. No.	Sec. No.	A	B	T	Wt. Range KG/12'
1	7029	100.00	65.00	1.60	6.000 - 6.400



Sl. No.	Sec. No.	A	B	T	Wt. Range KG/12'
1	7030	61.80	9.90	2.00	1.600 - 1.800

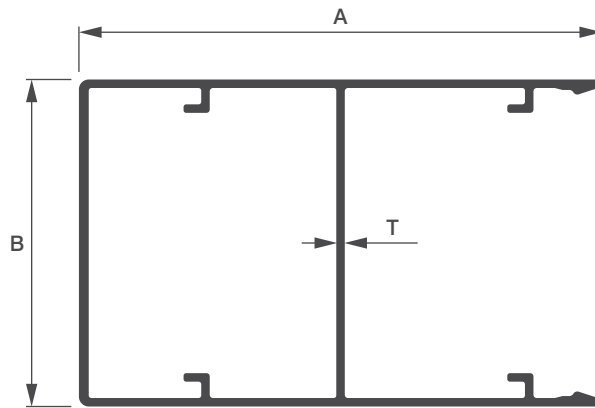

Sl. No.	Sec. No.	A	B	T	Wt. Range KG/12'
1	5451	80.00	50.00	1.30	3.700 - 4.300

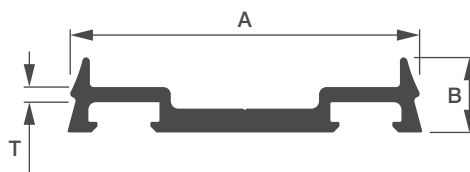

Sl. No.	Sec. No.	A	B	T	Wt. Range KG/12'
1	5452	46.20	9.90	2.00	1.550 - 1.950



CUP PLATES

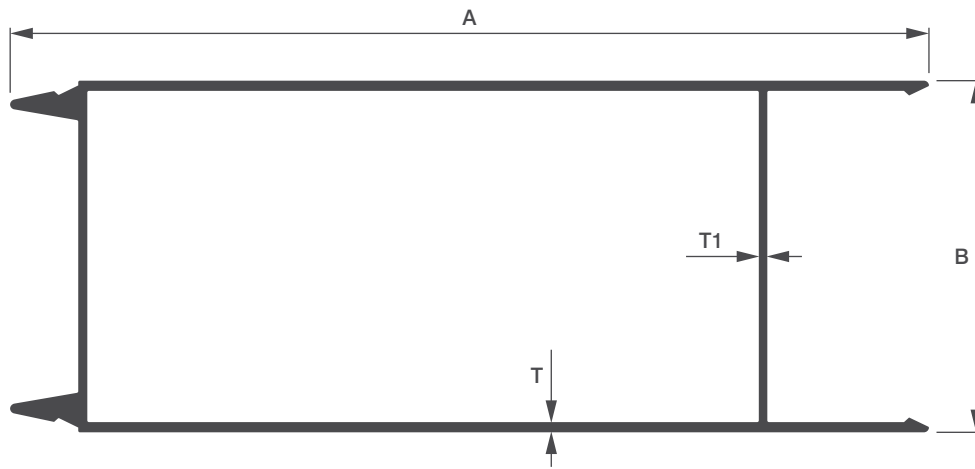

Sl. No.	Sec. No.	A	B	T	T1	Wt. Range KG/12'
1	5481	162.00	62.00	1.80	1.50	7.950 - 8.650

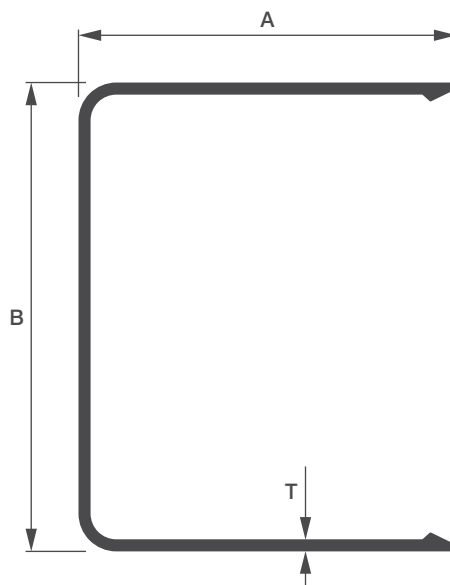

Sl. No.	Sec. No.	A	B	T	Wt. Range KG/12'
1	5482	50.00	62.00	1.60	2.450 - 2.950



Sl. No.	Sec. No.	A	B	T	Wt. Range KG/12'
1	5468	50.00	25.00	1.30	1.350 - 1.850



CUP PLATES

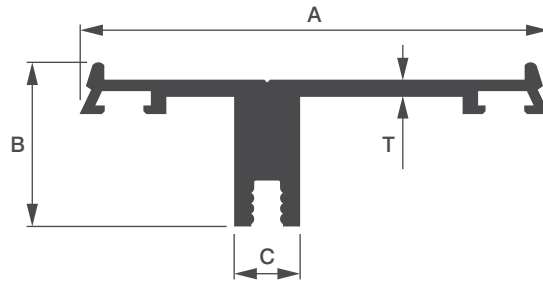

Sl. No.	Sec. No.	A	B	C	T	Wt. Range KG/12'
1	7710	81.66	28.60	11.50	3.00	4.200 - 4.800

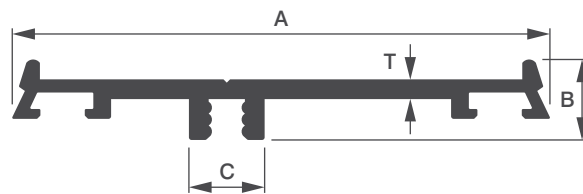

Sl. No.	Sec. No.	A	B	C	T	Wt. Range KG/12'
1	7711	81.66	12.20	11.50	3.00	3.000 - 3.600

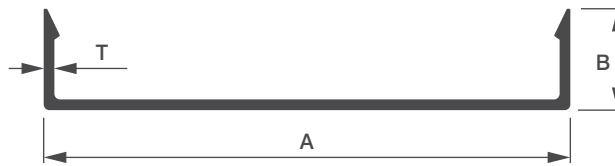

Sl. No.	Sec. No.	A	B	T	Wt. Range KG/12'
1	7712	83.50	16.07	1.70	1.850 - 2.450

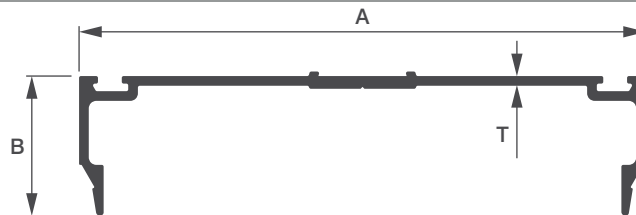

Sl. No.	Sec. No.	A	B	T	Wt. Range KG/12'
1	5329	150.00	37.00	2.57	6.400 - 6.800

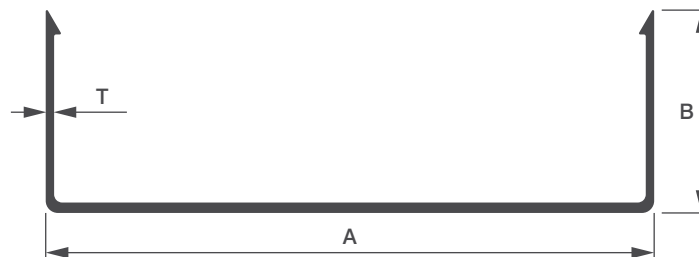

Sl. No.	Sec. No.	A	B	T	Wt. Range KG/12'
1	5328	150.00	50.00	2.07	5.700 - 6.100



CUP PLATES

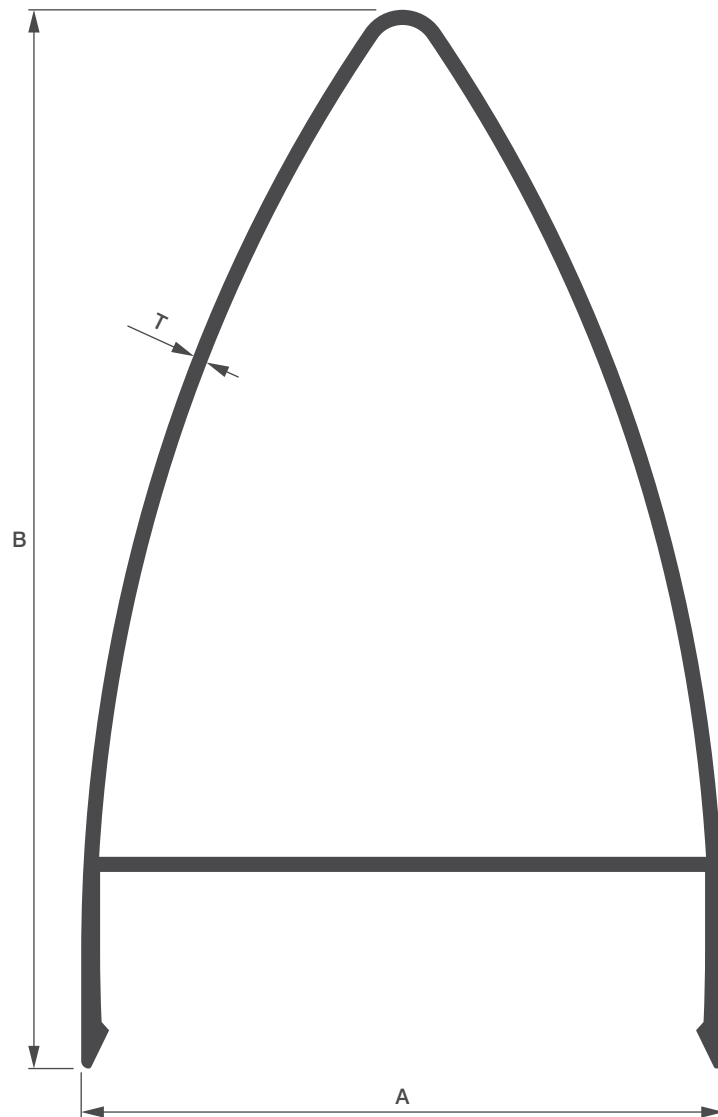

Sl. No.	Sec. No.	A	B	T	Wt. Range KG/12'
1	5475	85.00	140.00	2.00	7.700 - 8.300

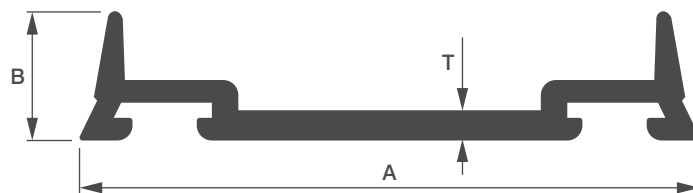

Sl. No.	Sec. No.	A	B	T	Wt. Range KG/12'
1	5476	82.00	17.00	4.00	4.100 - 4.600



CUP PLATES

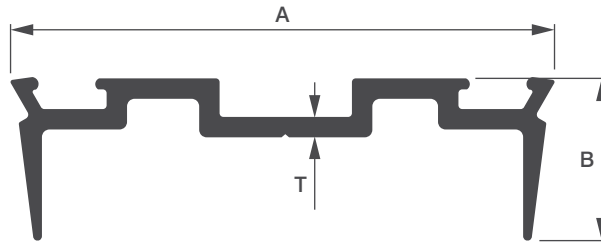

Sl. No.	Sec. No.	A	B	T	Wt. Range KG/12'
1	5632	71.90	21.45	2.70	3.150 - 3.450

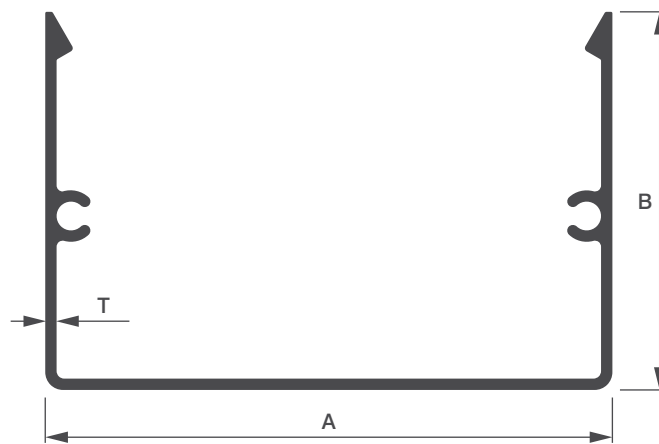

Sl. No.	Sec. No.	A	B	T	Wt. Range KG/12'
1	5633	75.00	50.00	1.50	2.900 - 3.300

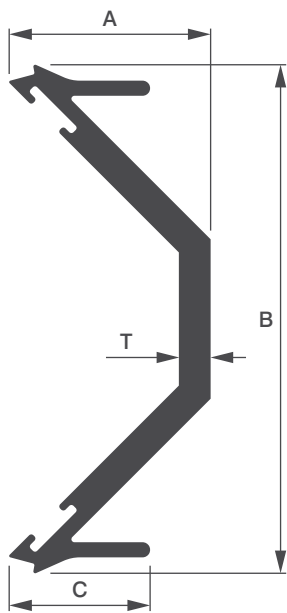

Sl. No.	Sec. No.	A	B	C	T	Wt. Range KG/12'
1	7834	26.64	67.24	18.64	4.20	3.600 - 4.100

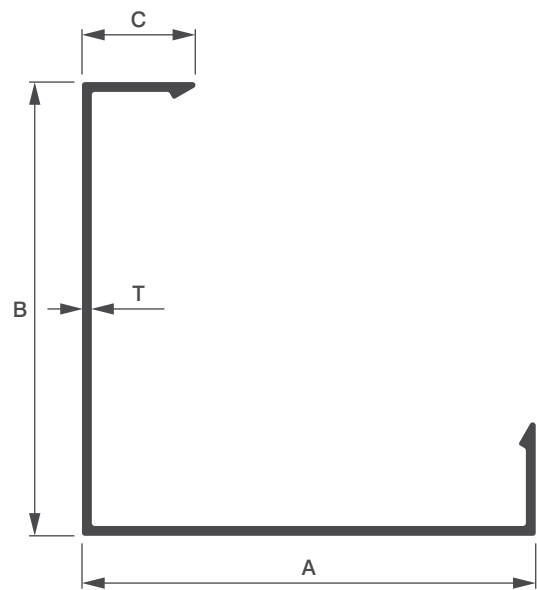

Sl. No.	Sec. No.	A	B	C	T	Wt. Range KG/12'
1	7835	60.00	60.00	15.00	1.30	1.800 - 2.300



CUP PLATES

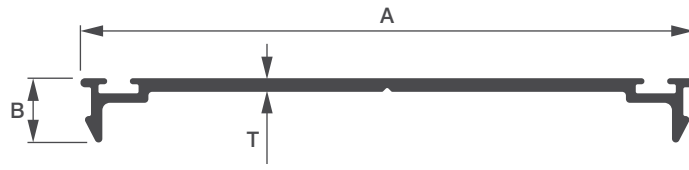

Sl. No.	Sec. No.	A	B	T	Wt. Range KG/12'
1	7849	81.13	8.50	1.80	1.600 - 1.900

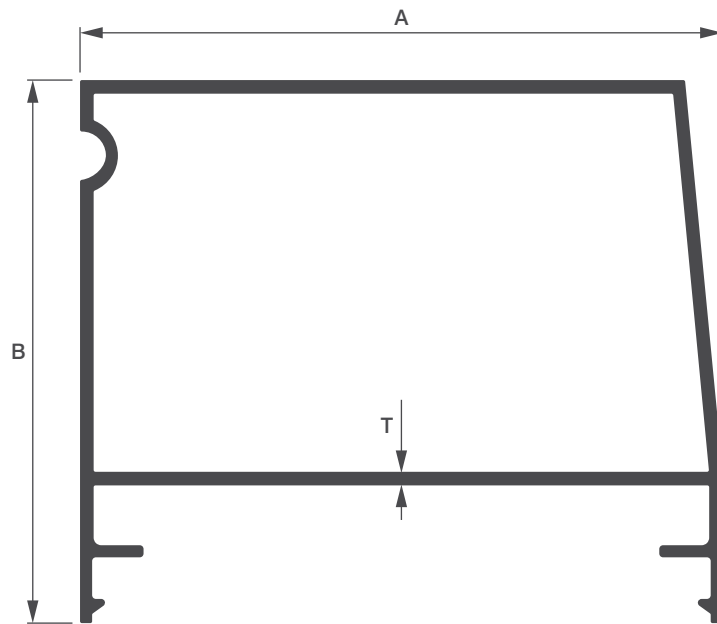

Sl. No.	Sec. No.	A	B	T	Wt. Range KG/12'
1	7850	85.00	71.81	1.80	5.600 - 6.100

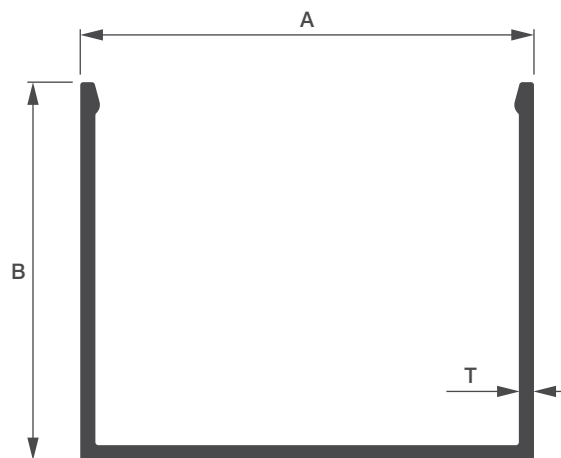

Sl. No.	Sec. No.	A	B	T	Wt. Range KG/12'
1	5653	60.00	50.00	2.00	3.100 - 3.500



CUP PLATES

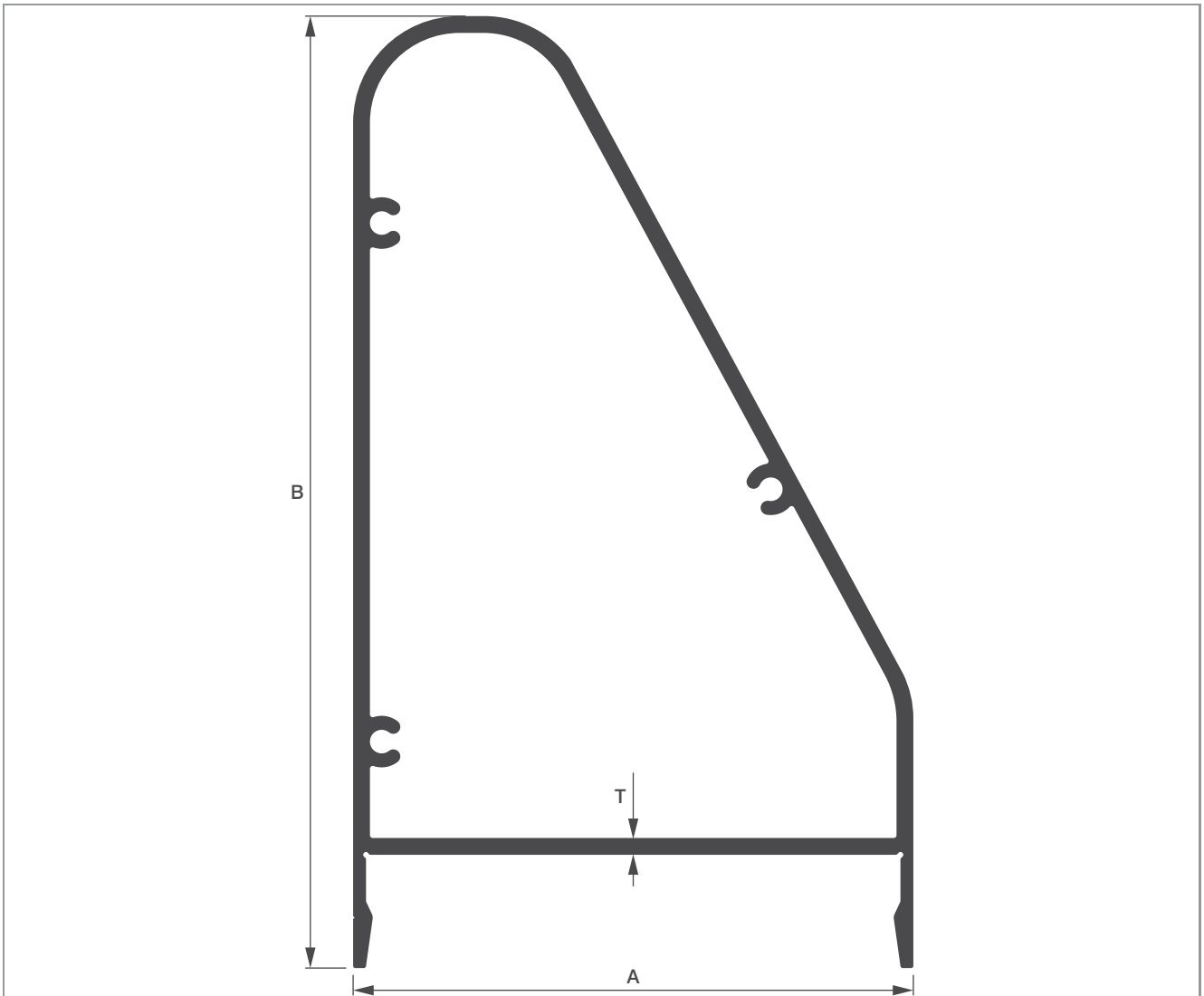

Sl. No.	Sec. No.	A	B	T	Wt. Range KG/12'
1	5646	99.95	169.80	3.00	14.500 - 14.900

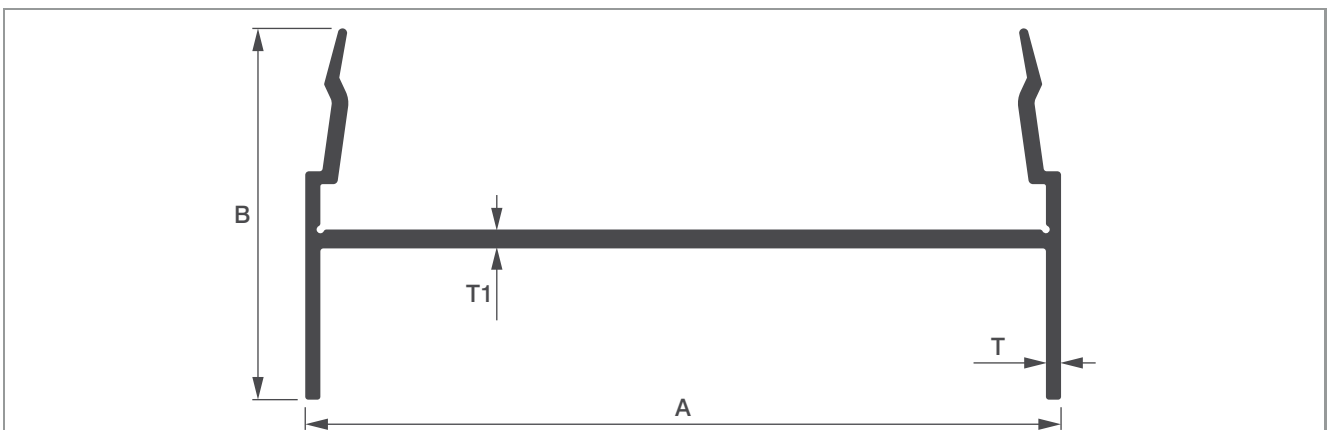

Sl. No.	Sec. No.	A	B	T	T1	Wt. Range KG/12'
1	5647	100.00	49.10	2.00	2.50	4.350 - 4.750