

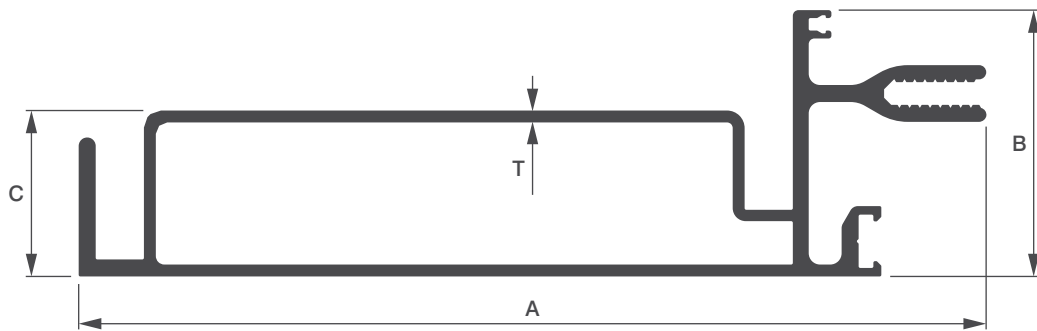

UNITIZED SYSTEMS

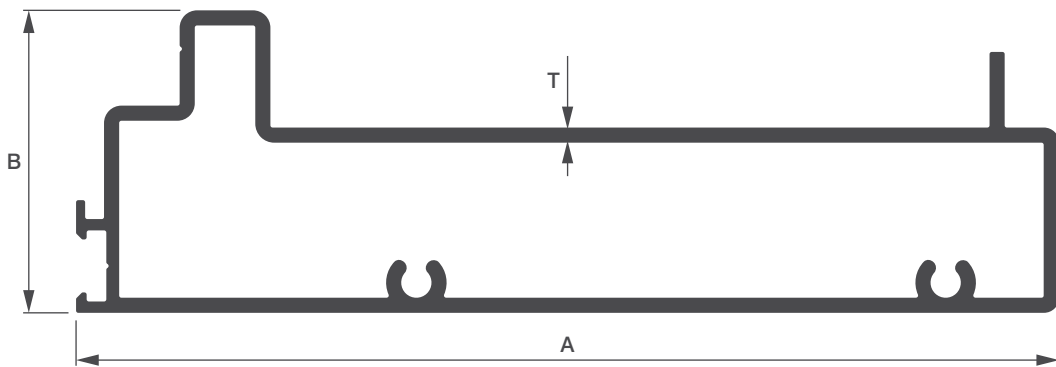

Sl. No.	Sec. No.	A	B	C	T	Wt. Range KG/12'
1	7020	160.00	46.96	29.25	2.10	10.200 - 10.500



Sl. No.	Sec. No.	A	B	T	Wt. Range KG/12'
1	7024	130.00	40.00	2.00	7.000 - 7.400

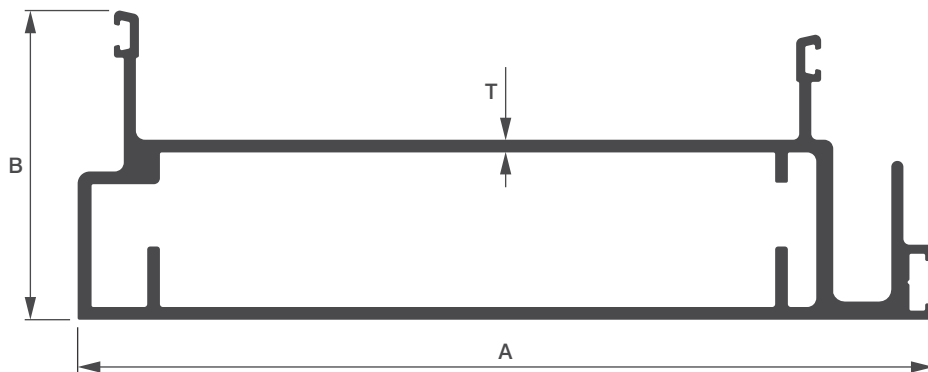

Sl. No.	Sec. No.	A	B	T	Wt. Range KG/12'
1	7027	141.50	51.10	2.10	9.000 - 9.400



UNITIZED SYSTEMS

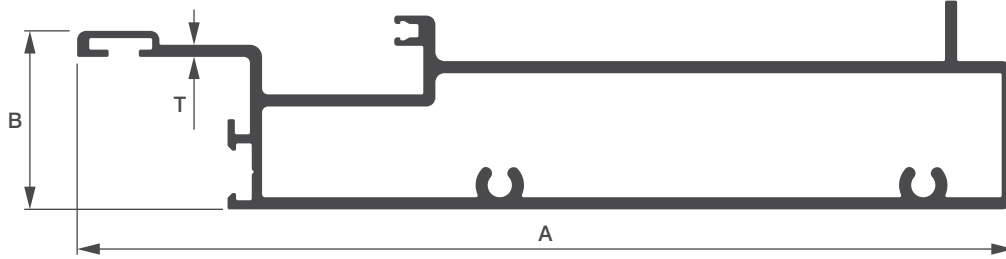

Sl. No.	Sec. No.	A	B	T	Wt. Range KG/12'
1	7028	154.86	29.50	2.00	7.600 - 8.000

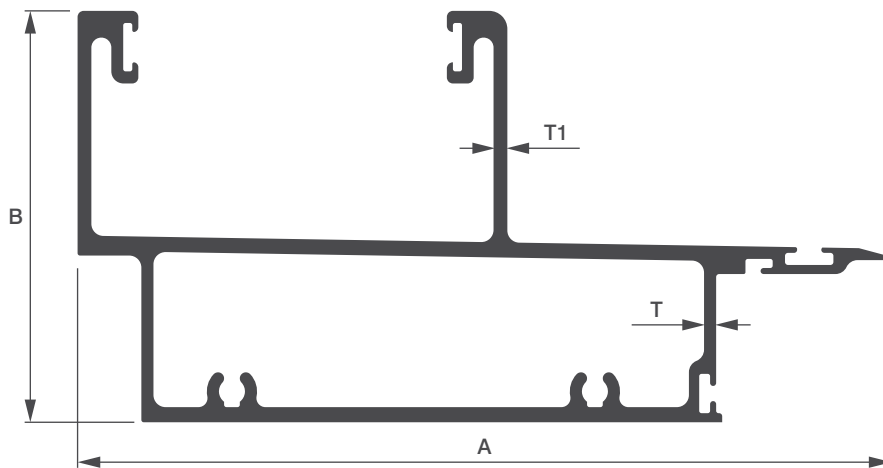

Sl. No.	Sec. No.	A	B	T	T1	Wt. Range KG/12'
1	7316	134.56	68.00	2.00	2.28	10.000 - 10.500

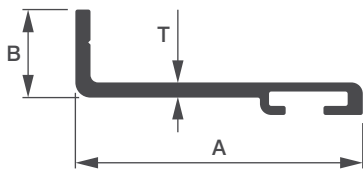

Sl. No.	Sec. No.	A	B	T	Wt. Range KG/12'
1	7025	38.00	11.64	2.00	1.000 - 1.150

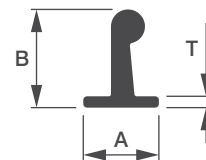

Sl. No.	Sec. No.	A	B	T	Wt. Range KG/12'
1	7026	10.00	13.00	1.50	0.500 - 0.550



UNITIZED SYSTEMS

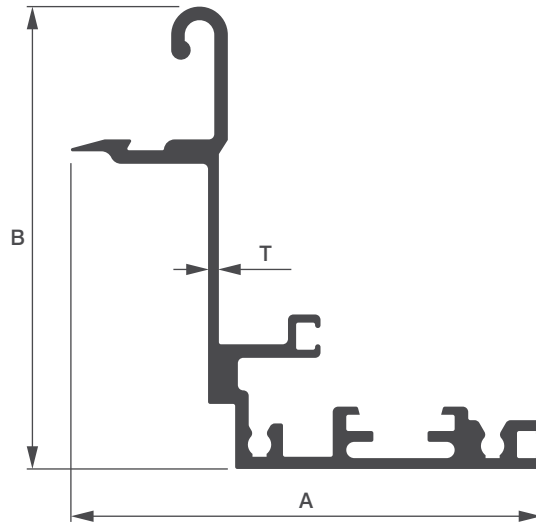

Sl. No.	Sec. No.	A	B	T	Wt. Range KG/12'
1	7317	86.80	85.30	2.00	6.300 - 6.800

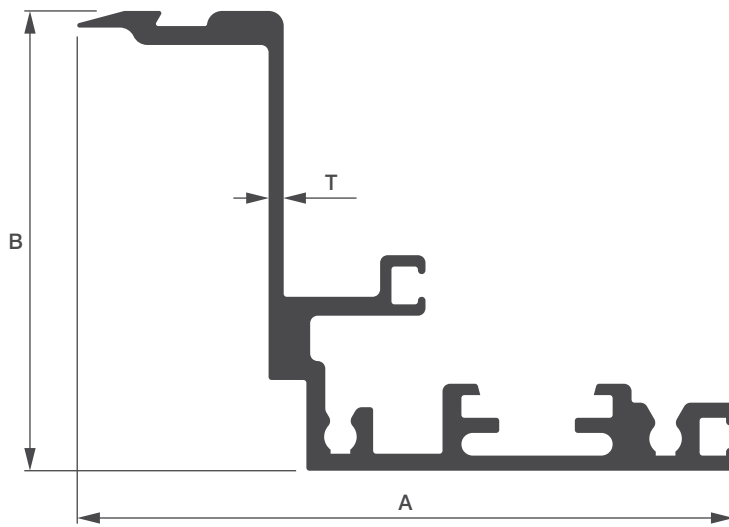

Sl. No.	Sec. No.	A	B	T	Wt. Range KG/12'
1	7318	86.80	60.80	2.00	5.300 - 5.700

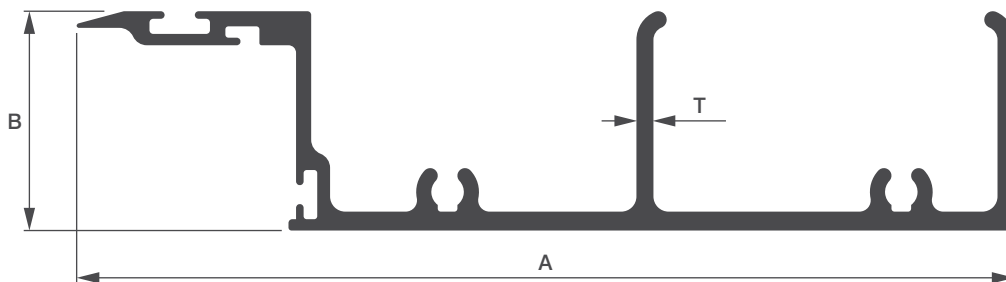

Sl. No.	Sec. No.	A	B	T	Wt. Range KG/12'
1	7319	124.00	29.00	2.25	5.300 - 5.700



UNITIZED SYSTEMS

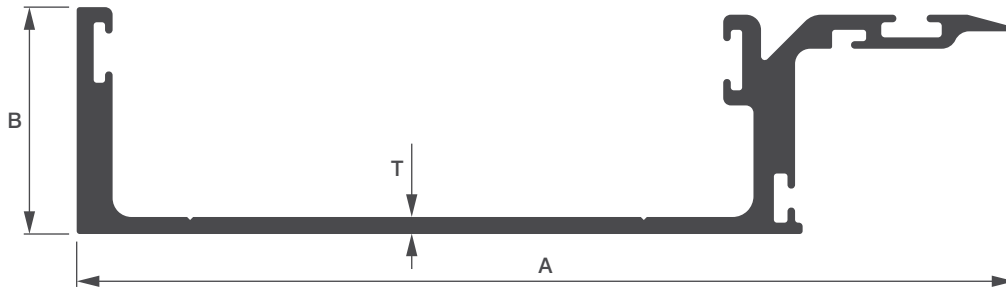

Sl. No.	Sec. No.	A	B	T	Wt. Range KG/12'
1	7320	124.00	30.00	2.25	1.400 - 1.700

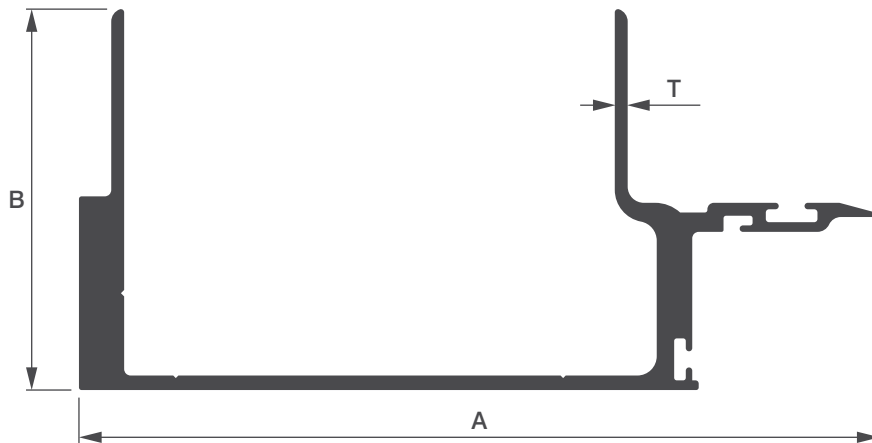

Sl. No.	Sec. No.	A	B	T	Wt. Range KG/12'
1	7321	124.00	59.00	2.00	7.300 - 7.700

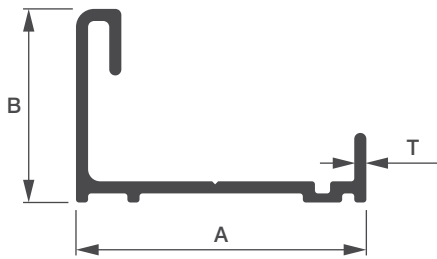

Sl. No.	Sec. No.	A	B	T	Wt. Range KG/12'
1	7322	48.00	32.00	2.00	2.000 - 2.200

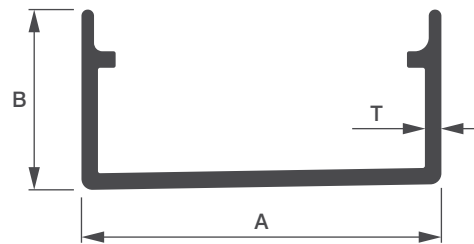

Sl. No.	Sec. No.	A	B	T	Wt. Range KG/12'
1	7323	65.48	32.80	3.00	3.700 - 4.00

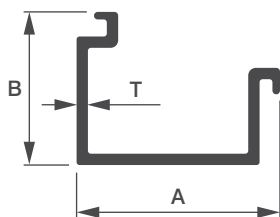

Sl. No.	Sec. No.	A	B	T	Wt. Range KG/12'
1	7324	26.90	20.25	1.50	0.920 - 1.100

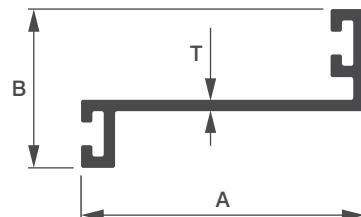

Sl. No.	Sec. No.	A	B	T	Wt. Range KG/12'
1	7230	50.00	28.00	2.00	1.800 - 2.000



UNITIZED SYSTEMS

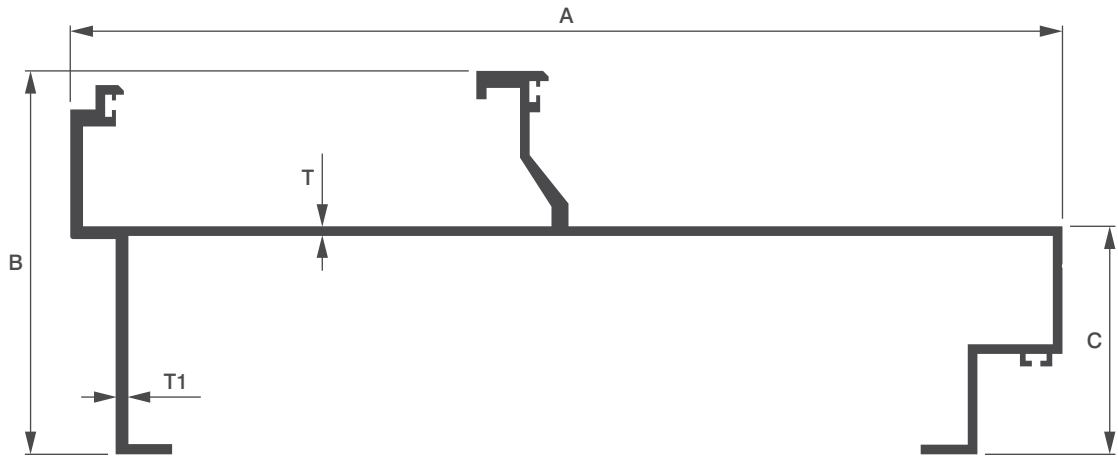

Sl. No.	Sec. No.	A	B	C	T	T1	Wt. Range KG/12'
1	5511	174.95	67.60	40.20	1.70	2.25	6.700 - 7.300

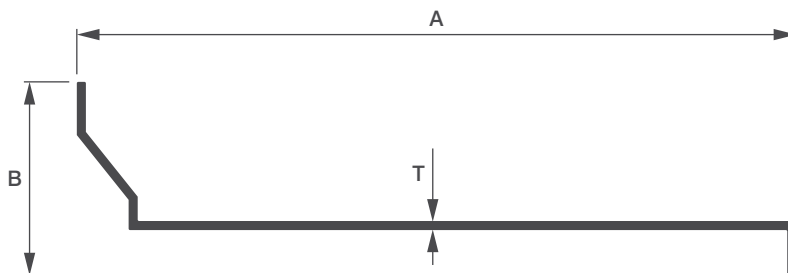

Sl. No.	Sec. No.	A	B	T	Wt. Range KG/12'
1	5512	95.20	25.60	1.20	1.300 - 1.700

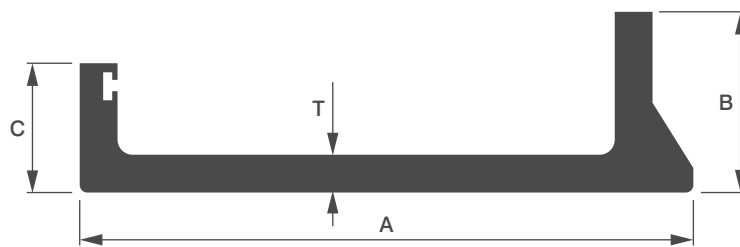

Sl. No.	Sec. No.	A	B	C	T	Wt. Range KG/12'
1	5513	81.15	23.90	17.10	5.00	5.600 - 6.300



UNITIZED SYSTEMS

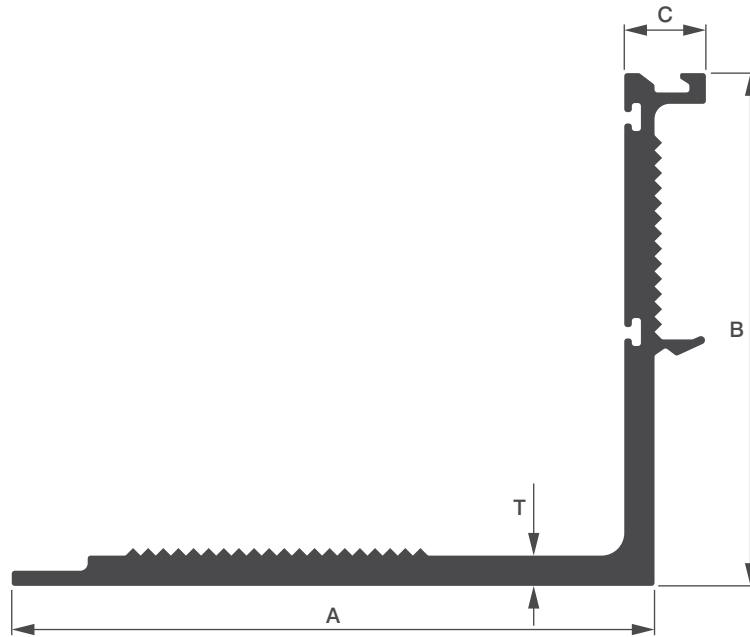

Sl. No.	Sec. No.	A	B	C	T	Wt. Range KG/12'
1	5514	85.00	67.80	10.80	4.00	6.100 - 6.800

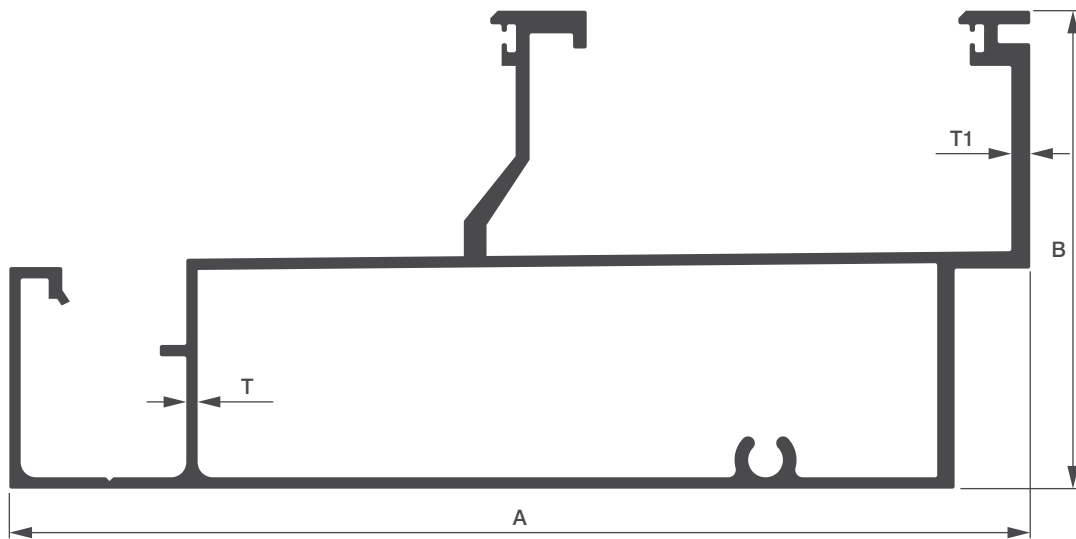

Sl. No.	Sec. No.	A	B	T	T1	Wt. Range KG/12'
1	5540	135.00	63.20	1.50	2.50	7.600 - 8.300



UNITIZED SYSTEMS

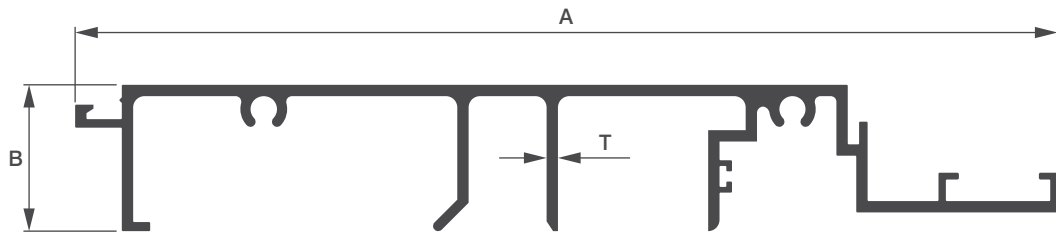

Sl. No.	Sec. No.	A	B	T	Wt. Range KG/12'
1	5516	173.20	25.80	2.00	6.700 - 7.200

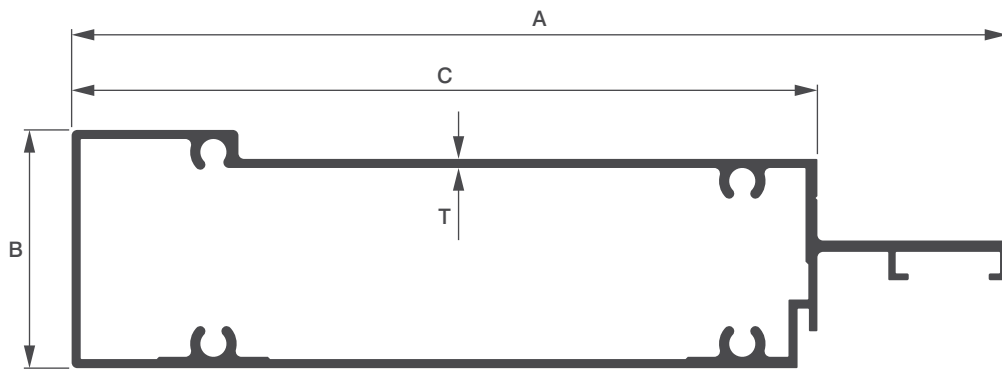

Sl. No.	Sec. No.	A	B	C	T	Wt. Range KG/12'
1	5517	165.00	42.00	131.50	1.60	7.300 - 7.900

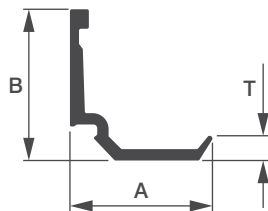

Sl. No.	Sec. No.	A	B	T	Wt. Range KG/12'
1	5518	18.85	20.00	3.30	0.550 - 0.850

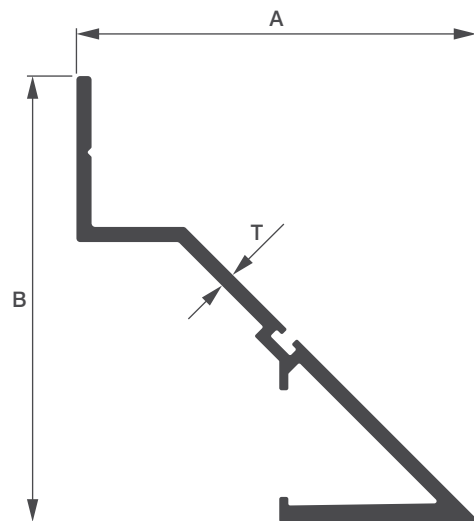

Sl. No.	Sec. No.	A	B	T	Wt. Range KG/12'
1	5520	52.90	58.90	2.00	2.300 - 2.800



UNITIZED SYSTEMS

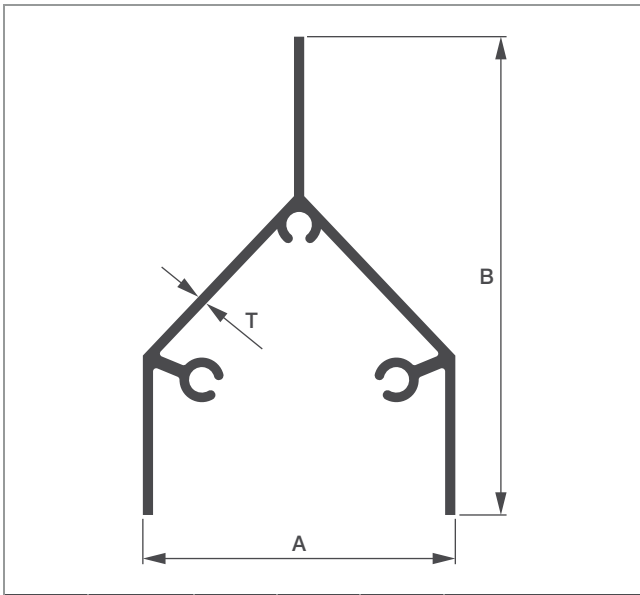

Sl. No.	Sec. No.	A	B	T	Wt. Range KG/12'
1	5527	49.00	75.00	1.60	2.900 - 3.500

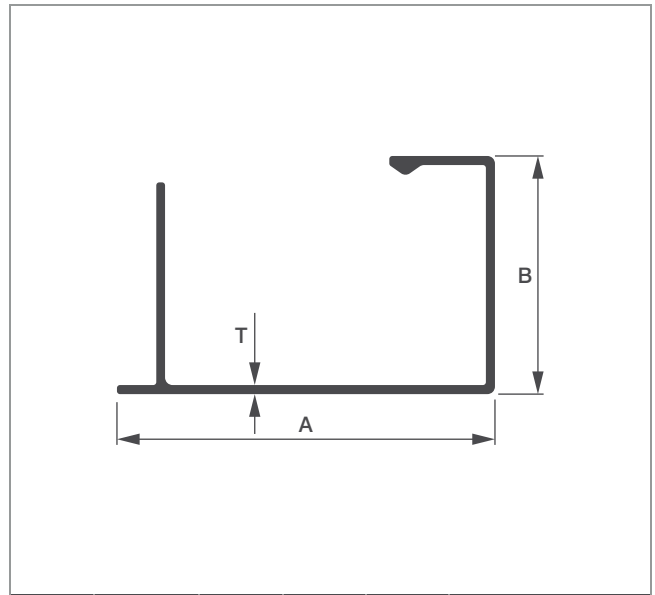

Sl. No.	Sec. No.	A	B	T	Wt. Range KG/12'
1	5528	50.00	31.50	1.20	1.400 - 1.900

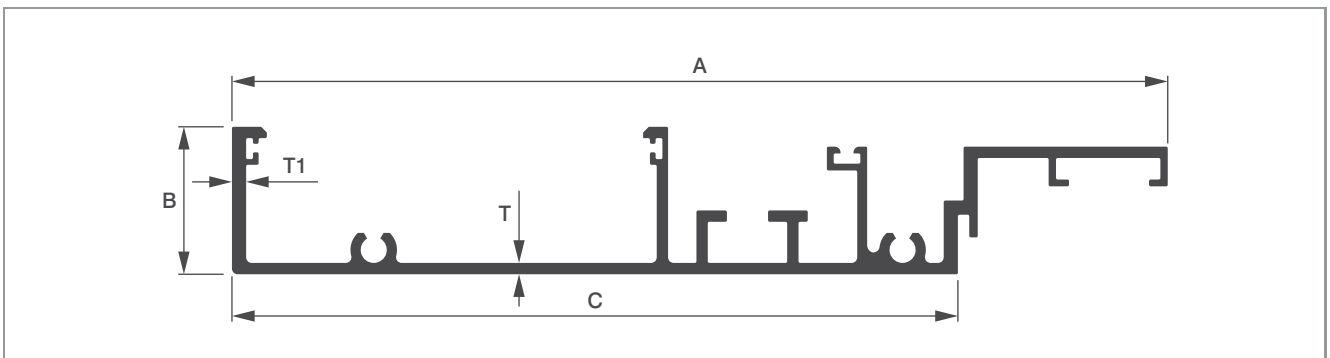

Sl. No.	Sec. No.	A	B	C	T	T1	Wt. Range KG/12'
1	5530	165.00	26.00	128.00	2.00	2.50	6.700 - 7.400

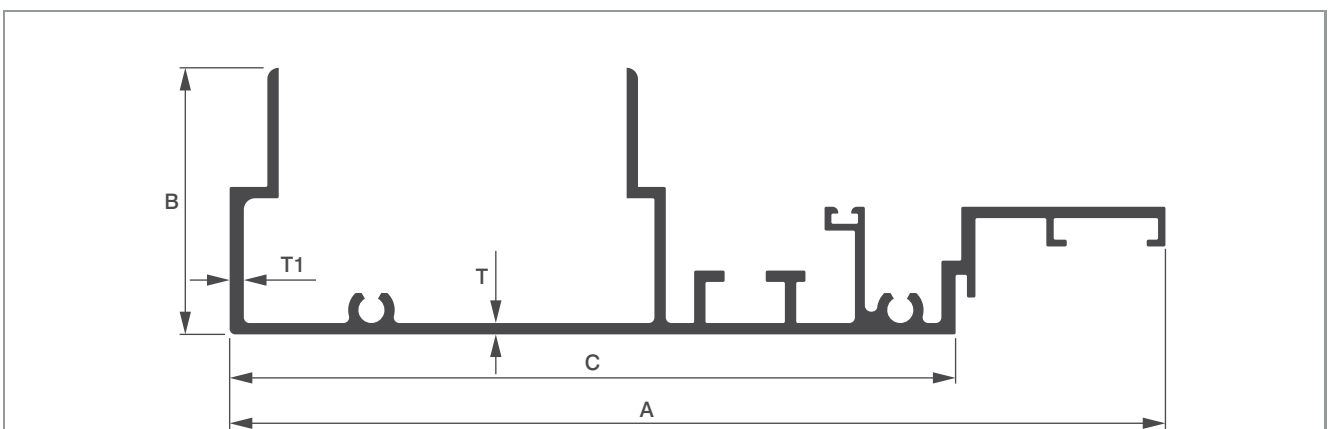

Sl. No.	Sec. No.	A	B	C	T	T1	Wt. Range KG/12'
1	5531	165.00	47.00	128.00	2.00	2.50	7.600 - 8.200



UNITIZED SYSTEMS

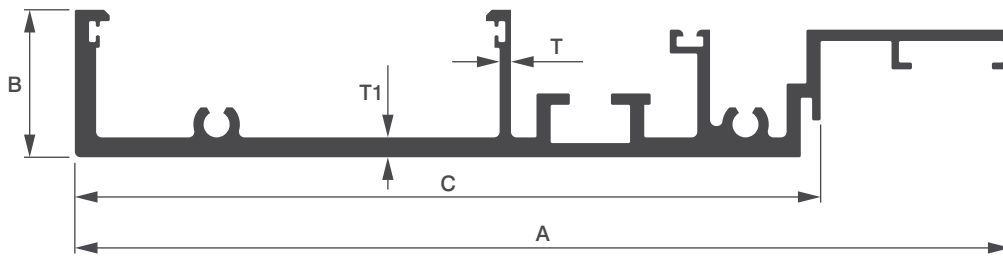

Sl. No.	Sec. No.	A	B	C	T	T1	Wt. Range KG/12'
1	5532	165.00	26.00	131.50	2.00	3.50	8.600 - 9.300

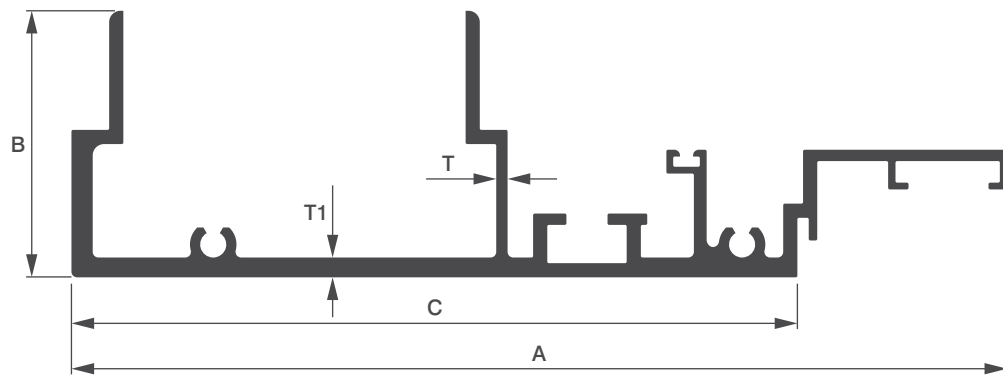

Sl. No.	Sec. No.	A	B	C	T	T1	Wt. Range KG/12'
1	5533	165.00	47.00	128.00	2.00	3.50	9.850 - 10.450

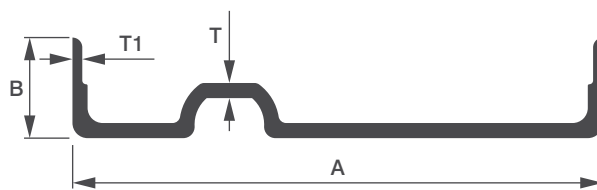

Sl. No.	Sec. No.	A	B	T	T1	Wt. Range KG/12'
1	5534	70.12	13.30	2.00	1.30	1.800 - 2.400

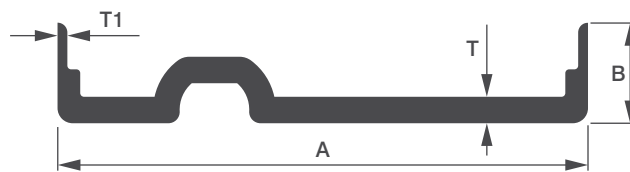

Sl. No.	Sec. No.	A	B	T	T1	Wt. Range KG/12'
1	5535	70.12	13.25	3.50	1.30	3.000 - 3.500



UNITIZED SYSTEMS

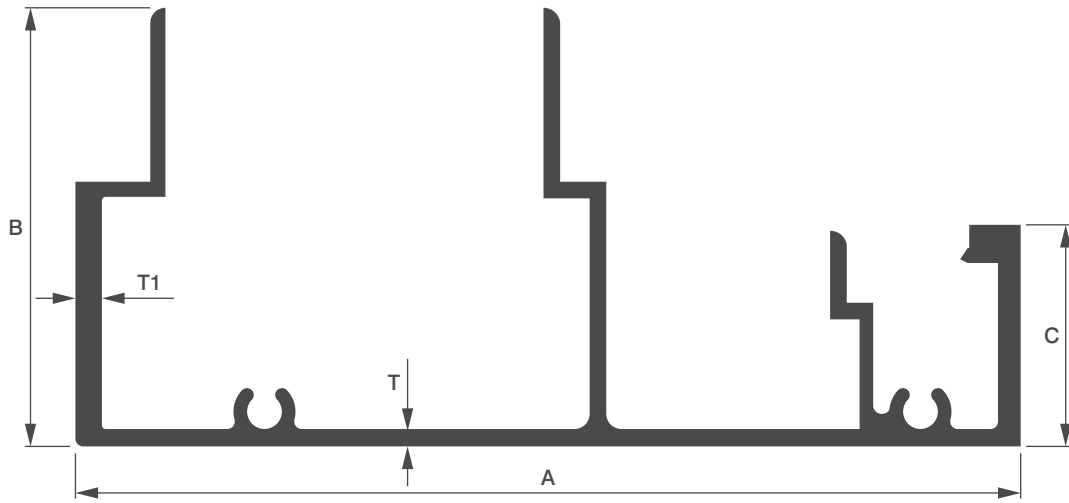

Sl. No.	Sec. No.	A	B	C	T	T1	Wt. Range KG/12'
1	5536	125.00	58.00	29.30	2.30	3.50	7.950 - 8.450

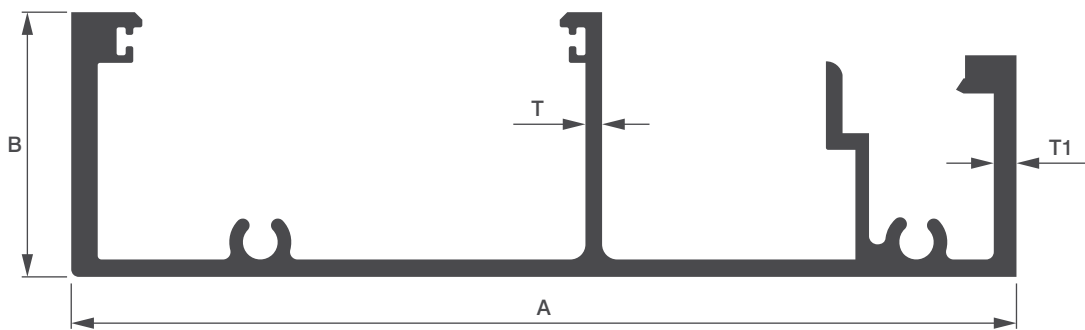

Sl. No.	Sec. No.	A	B	T	T1	Wt. Range KG/12'
1	5537	125.00	35.00	2.20	3.00	7.100 - 7.800

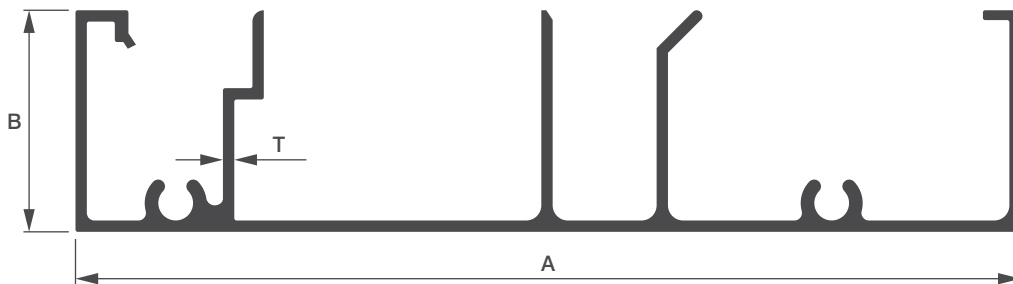

Sl. No.	Sec. No.	A	B	T	Wt. Range KG/12'
1	5539	125.00	29.30	1.50	4.650 - 5.350



UNITIZED SYSTEMS

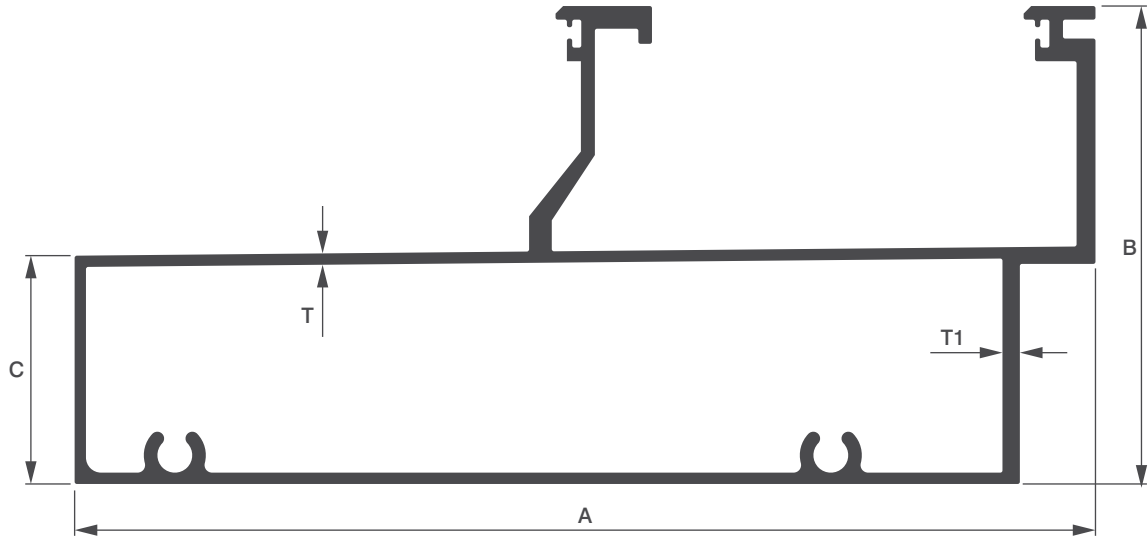

Sl. No.	Sec. No.	A	B	C	T	T1	Wt. Range KG/12'
1	5541	135.00	63.20	30.19	1.50	2.30	7.500 - 8.200

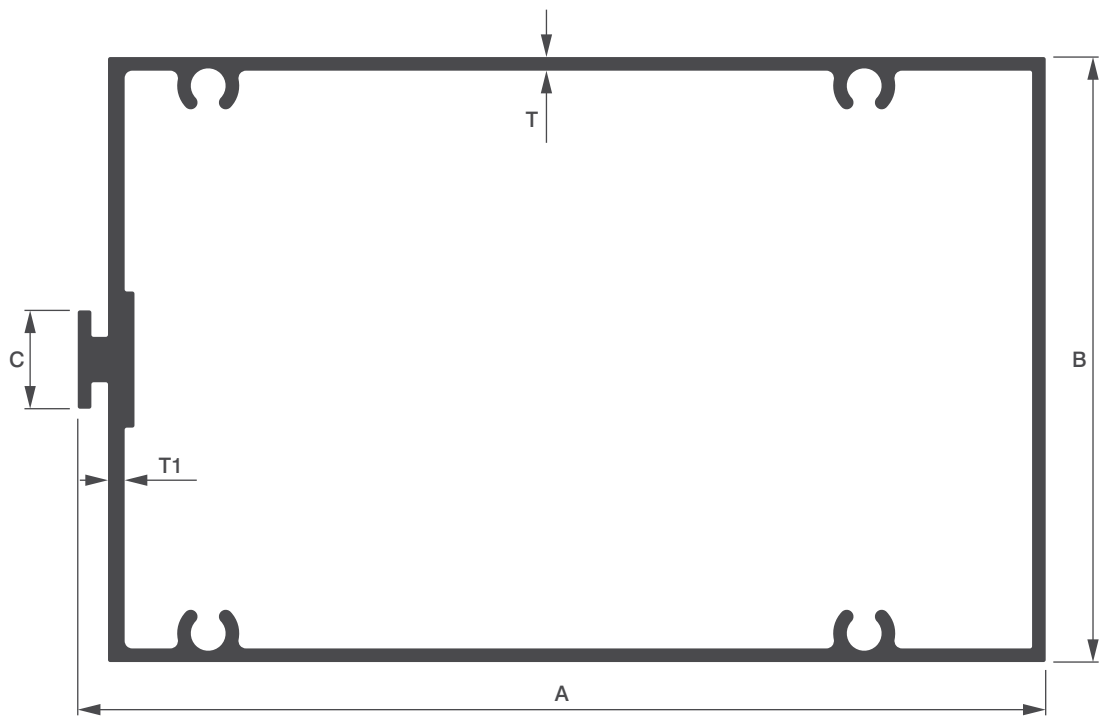

Sl. No.	Sec. No.	A	B	C	T	T1	Wt. Range KG/12'
1	5542	128.00	80.00	13.00	1.80	2.20	8.750 - 9.350



UNITIZED SYSTEMS

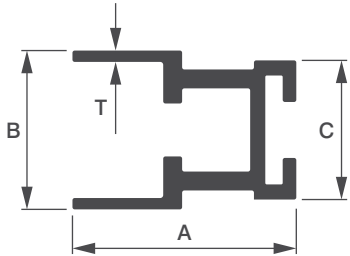

Sl. No.	Sec. No.	A	B	C	T	Wt. Range KG/12'
1	5543	29.60	21.00	18.40	1.50	1.750 - 2.300

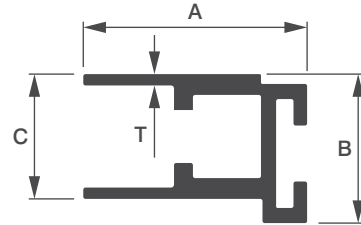

Sl. No.	Sec. No.	A	B	C	T	Wt. Range KG/12'
1	5544	29.60	19.70	16.50	1.50	1.700 - 2.200

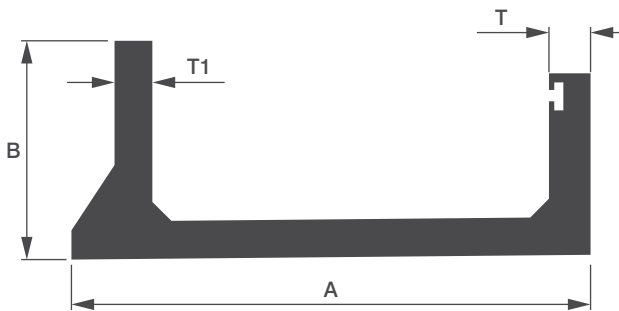

Sl. No.	Sec. No.	A	B	T	T1	Wt. Range KG/12'
1	5547	68.70	28.90	5.50	5.00	5.750 - 6.350

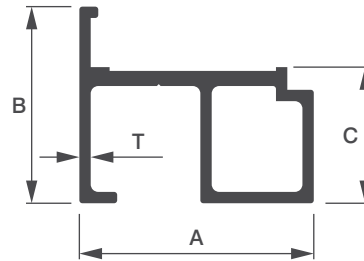

Sl. No.	Sec. No.	A	B	C	T	Wt. Range KG/12'
1	5549	31.00	26.00	18.00	1.50	1.600 - 2.200

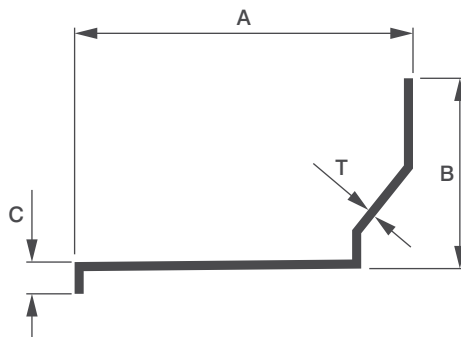

Sl. No.	Sec. No.	A	B	C	T	Wt. Range KG/12'
1	5545	44.75	25.16	4.20	1.20	0.800 - 1.200
2	5546	68.10	25.20	4.20	1.20	0.950 - 1.350



UNITIZED SYSTEMS

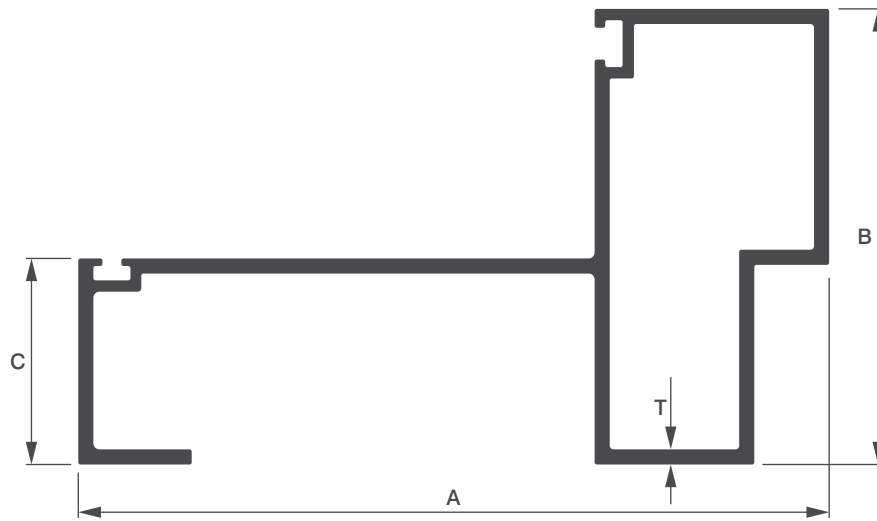

Sl. No.	Sec. No.	A	B	C	T	Wt. Range KG/12'
1	5548	99.30	60.20	27.20	2.00	5.600 - 6.300

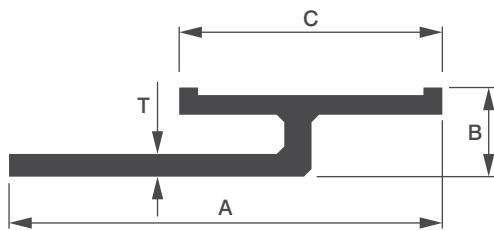

Sl. No.	Sec. No.	A	B	C	T	Wt. Range KG/12'
1	5550	57.30	11.78	34.80	3.00	2.300 - 2.700

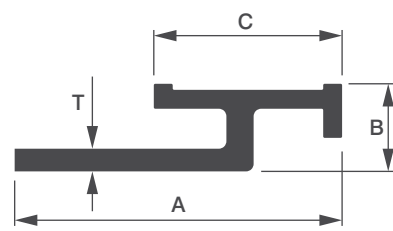

Sl. No.	Sec. No.	A	B	C	T	Wt. Range KG/12'
1	5561	43.30	11.58	24.90	3.00	1.800 - 2.400

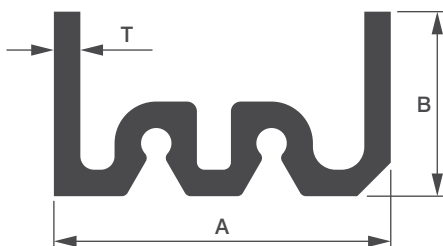

Sl. No.	Sec. No.	A	B	T	Wt. Range KG/12'
1	5562	44.55	24.40	3.50	3.900 - 4.500

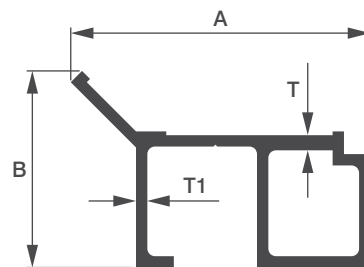

Sl. No.	Sec. No.	A	B	T	T1	Wt. Range KG/12'
1	5563	39.60	26.00	1.50	2.00	1.650 - 2.350



UNITIZED SYSTEMS

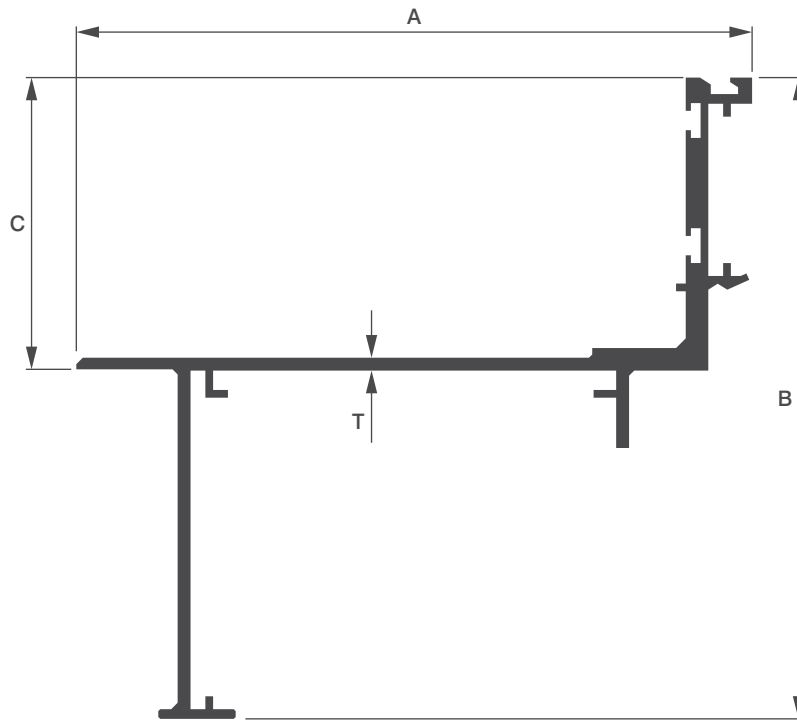

Sl. No.	Sec. No.	A	B	C	T	Wt. Range KG/12'
1	5564	104.80	99.45	45.44	2.00	5.300 - 5.900

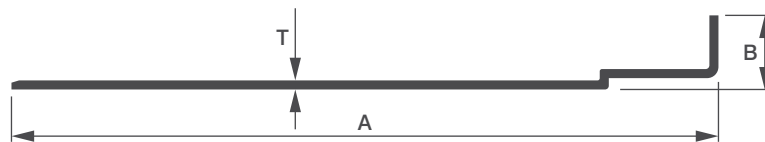

Sl. No.	Sec. No.	A	B	T	Wt. Range KG/12'
1	5565	93.50	9.80	1.20	1.200 - 1.700

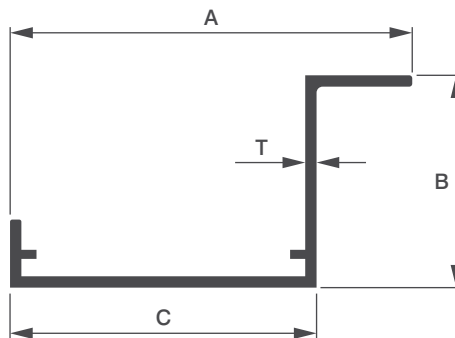

Sl. No.	Sec. No.	A	B	C	T	Wt. Range KG/12'
1	5566	53.17	28.10	40.54	1.50	1.300 - 1.800



UNITIZED SYSTEMS

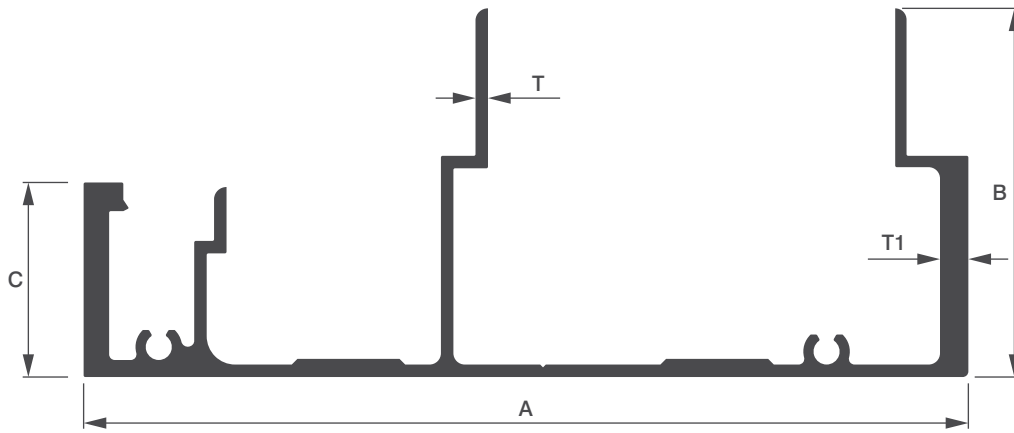

Sl. No.	Sec. No.	A	B	C	T	T1	Wt. Range KG/12'
1	5638	156.00	65.00	34.30	2.20	5.00	10.700 - 11.100

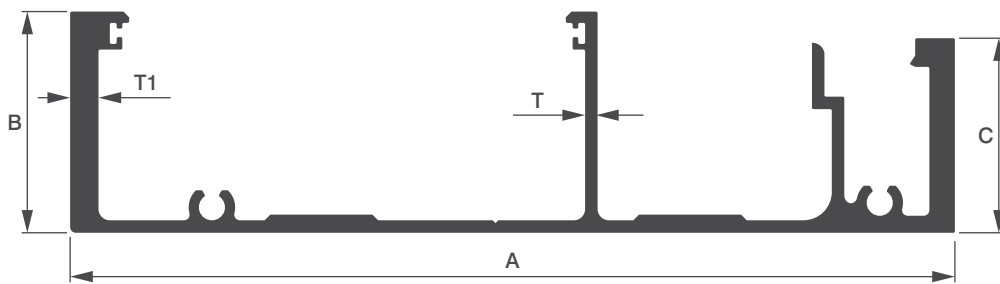

Sl. No.	Sec. No.	A	B	C	T	T1	Wt. Range KG/12'
1	5639	156.00	39.00	34.30	2.20	5.00	9.700 - 10.200

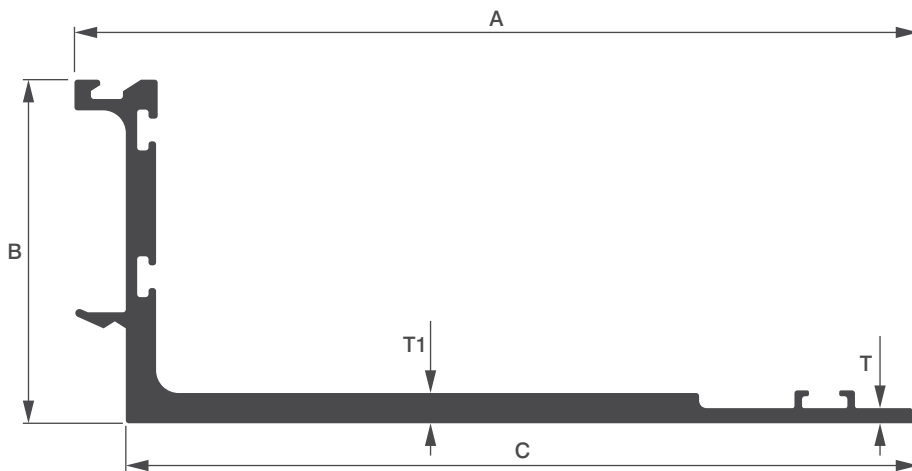

Sl. No.	Sec. No.	A	B	C	T	T1	Wt. Range KG/12'
1	5627	111.60	45.40	104.80	2.00	4.00	5.350 - 5.750



UNITIZED SYSTEMS

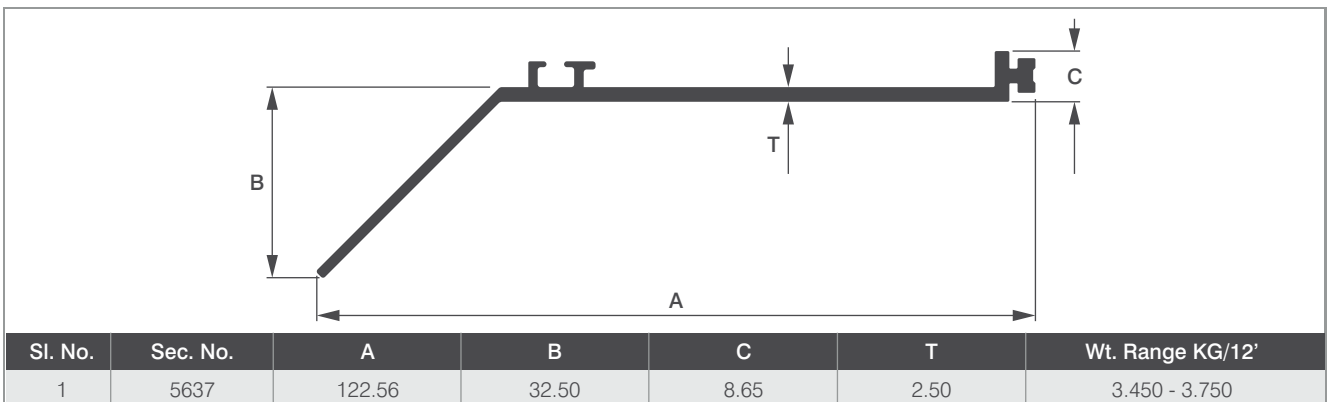
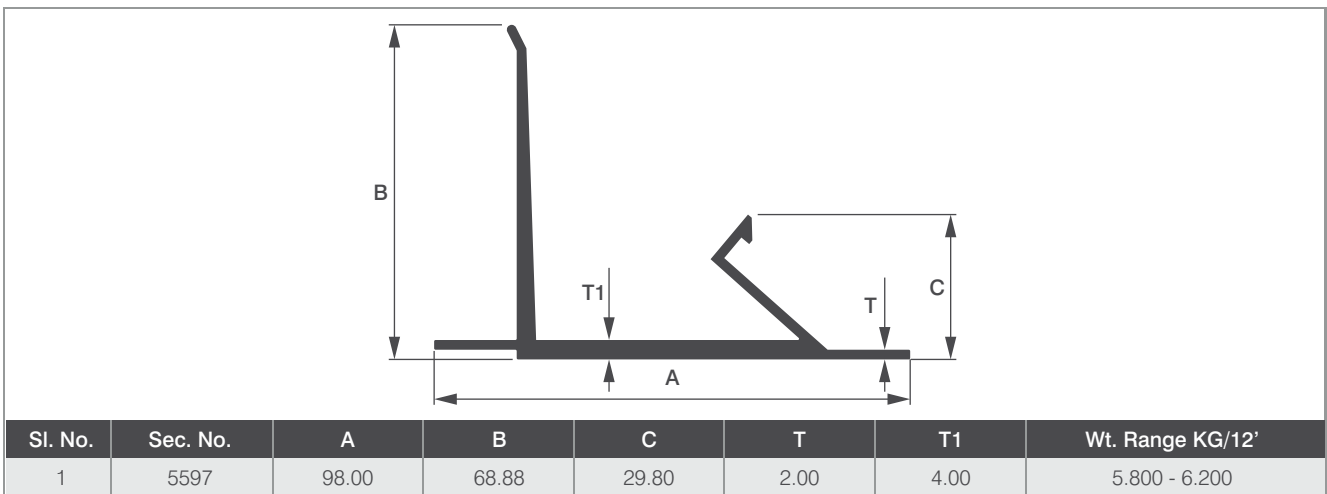
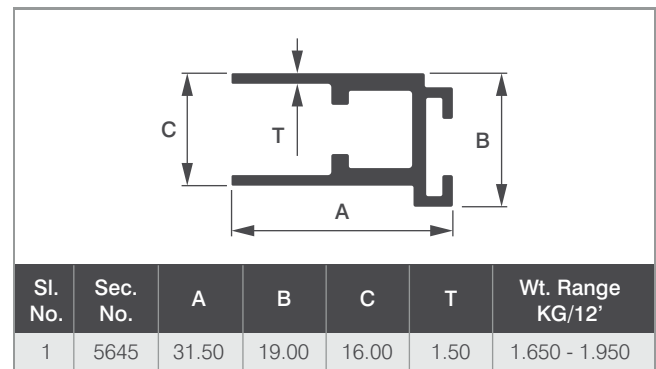
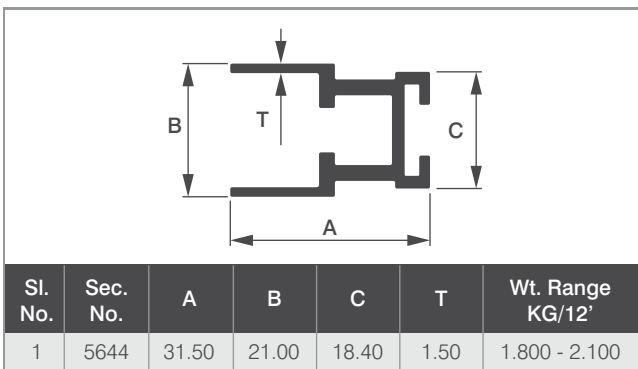
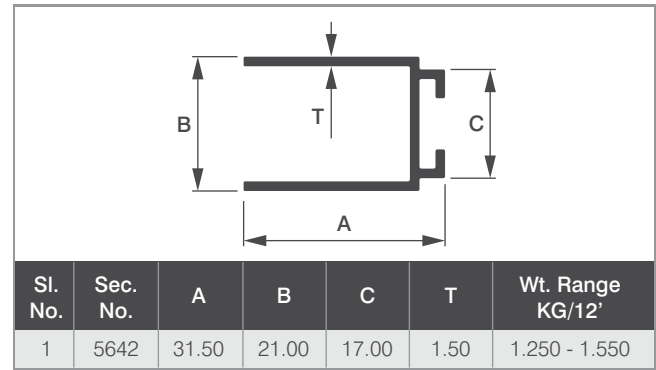
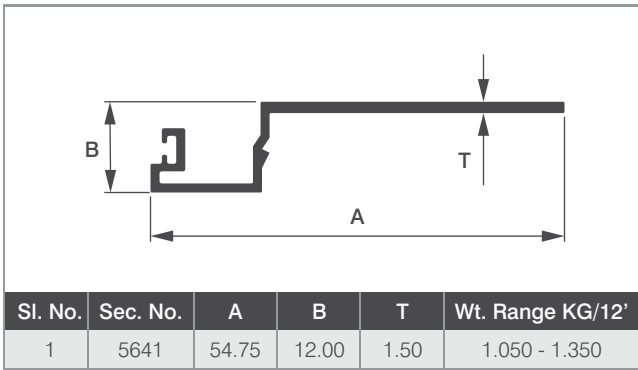



UNITIZED SYSTEMS

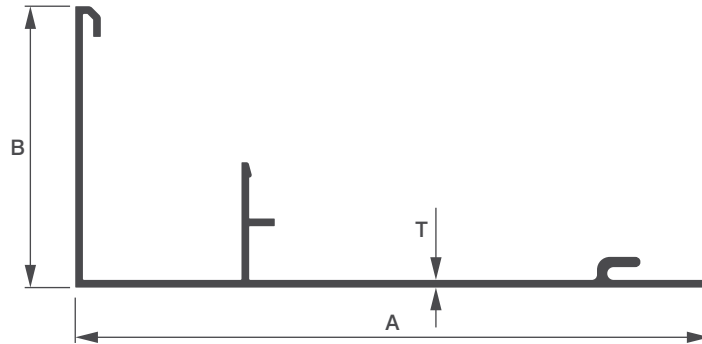

Sl. No.	Sec. No.	A	B	T	Wt. Range KG/12'
1	7801	124.00	55.00	1.50	3.300 - 3.600

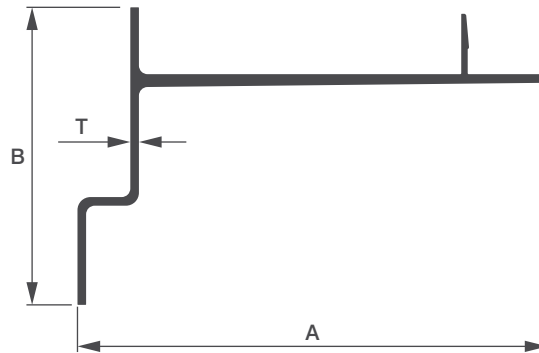

Sl. No.	Sec. No.	A	B	T	Wt. Range KG/12'
1	7802	109.00	69.00	2.00	4.100 - 4.500

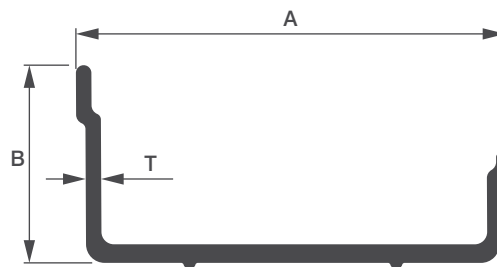

Sl. No.	Sec. No.	A	B	T	Wt. Range KG/12'
1	7807	69.35	31.92	2.50	3.000 - 3.300

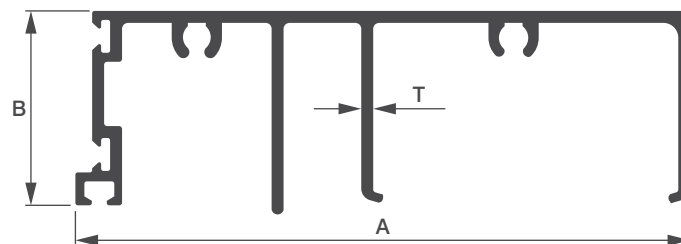

Sl. No.	Sec. No.	A	B	T	Wt. Range KG/12'
1	7806	102.80	32.50	2.00	5.100 - 5.500



UNITIZED SYSTEMS

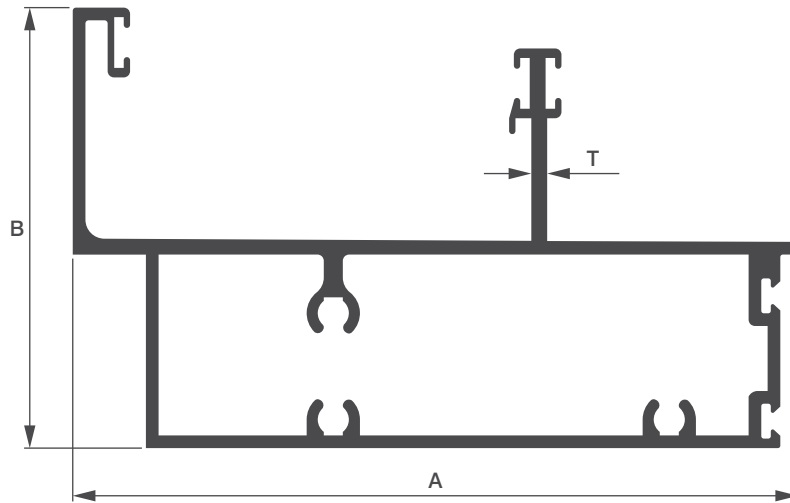

Sl. No.	Sec. No.	A	B	T	Wt. Range KG/12'
1	7805	114.33	69.43	2.50	8.800 - 9.200

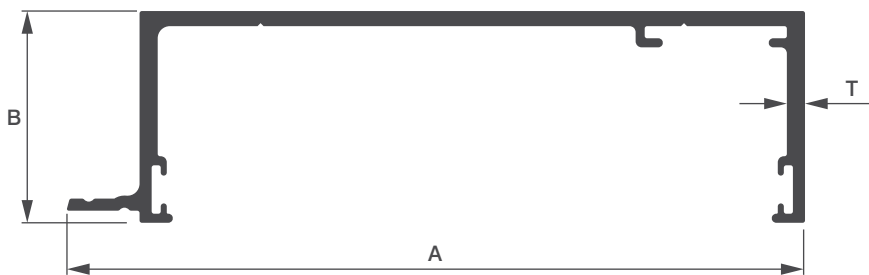

Sl. No.	Sec. No.	A	B	T	Wt. Range KG/12'
1	7809	121.77	35.00	3.00	5.000 - 5.400



Sl. No.	Sec. No.	A	B	T	T1	Wt. Range KG/12'
1	7810	122.00	65.50	4.00	2.50	7.300 - 7.700



UNITIZED SYSTEMS

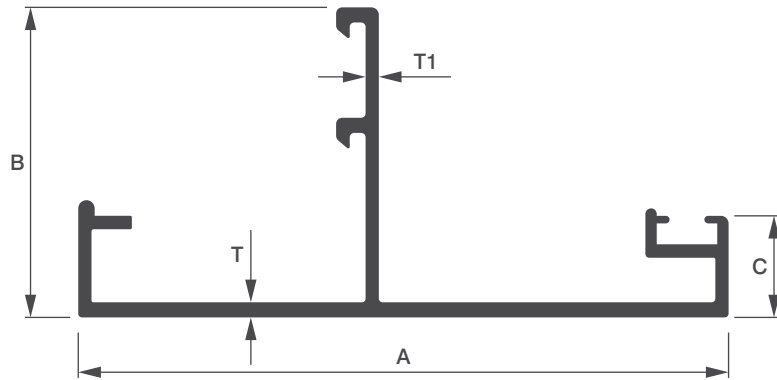

Sl. No.	Sec. No.	A	B	C	T	T1	Wt. Range KG/12'
1	7817	86.00	41.00	13.40	2.00	1.75	3.300 - 3.600

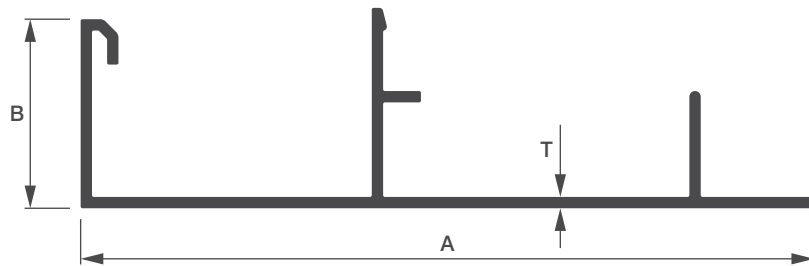

Sl. No.	Sec. No.	A	B	T	Wt. Range KG/12'
1	7851	97.00	25.00	1.50	2.500 - 3.100

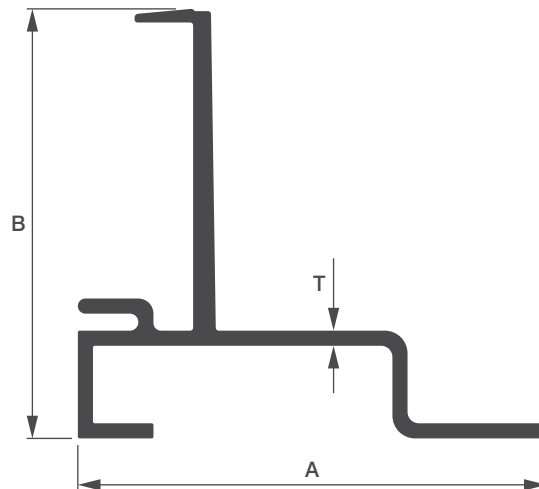

Sl. No.	Sec. No.	A	B	T	Wt. Range KG/12'
1	7852	62.00	56.80	2.00	3.300 - 3.900



UNITIZED SYSTEMS

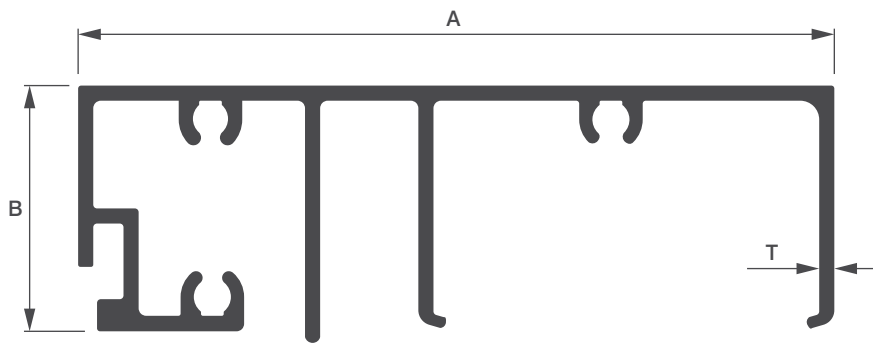

Sl. No.	Sec. No.	A	B	T	Wt. Range KG/12'
1	7858	100.00	32.49	2.00	5.800 - 6.500

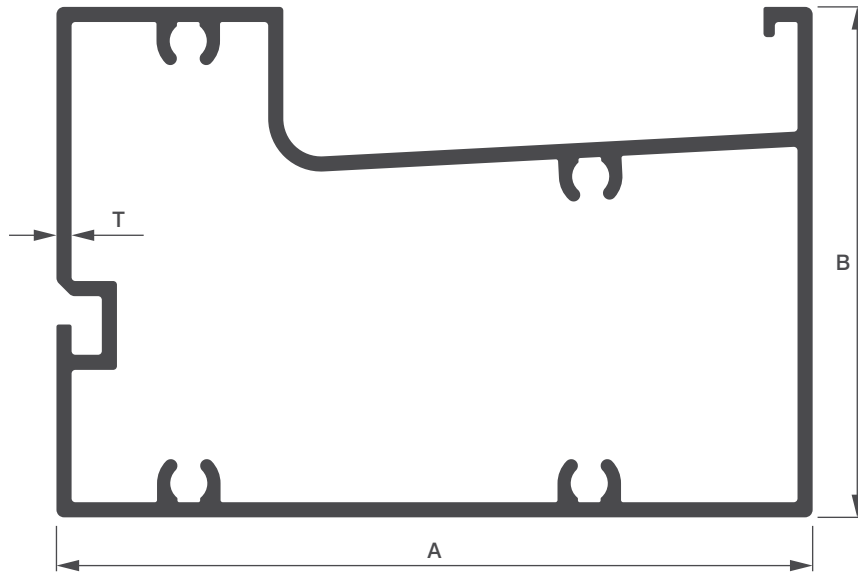

Sl. No.	Sec. No.	A	B	T	Wt. Range KG/12'
1	7859	100.00	67.50	2.00	8.000 - 8.600

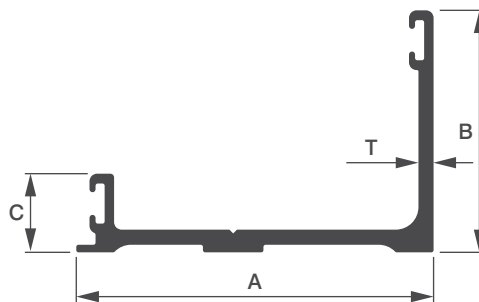

Sl. No.	Sec. No.	A	B	C	T	Wt. Range KG/12'
1	7861	47.25	32.00	10.40	2.00	1.800 - 2.400



UNITIZED SYSTEMS

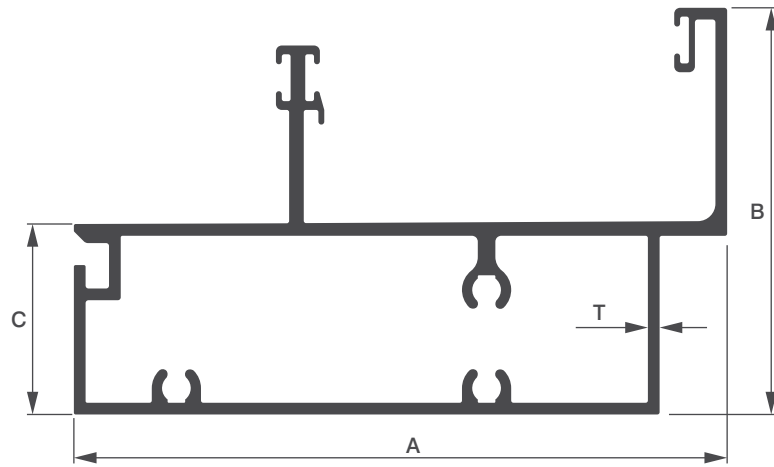

Sl. No.	Sec. No.	A	B	C	T	Wt. Range KG/12'
1	7857	111.50	69.43	32.50	2.00	8.700 - 9.400

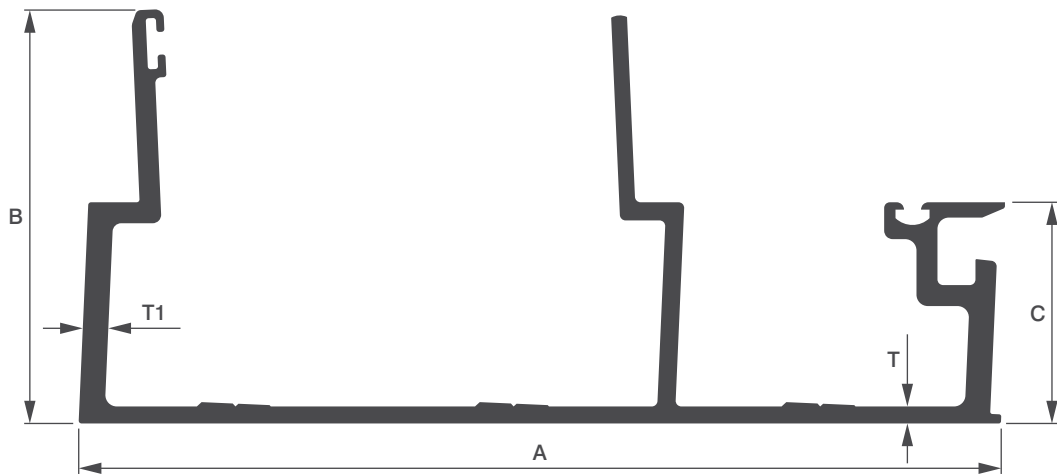

Sl. No.	Sec. No.	A	B	C	T	T1	Wt. Range KG/12'
1	7862	162.65	72.90	39.00	3.00	4.50	12.900 - 13.400

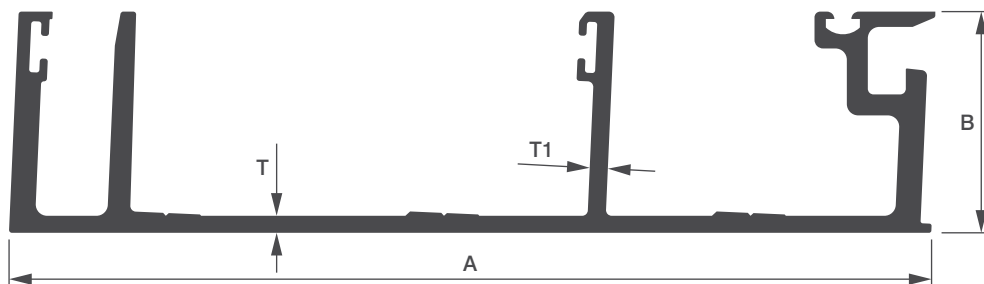

Sl. No.	Sec. No.	A	B	T	T1	Wt. Range KG/12'
1	7863	162.65	39.00	3.00	3.20	11.550 - 11.950



UNITIZED SYSTEMS

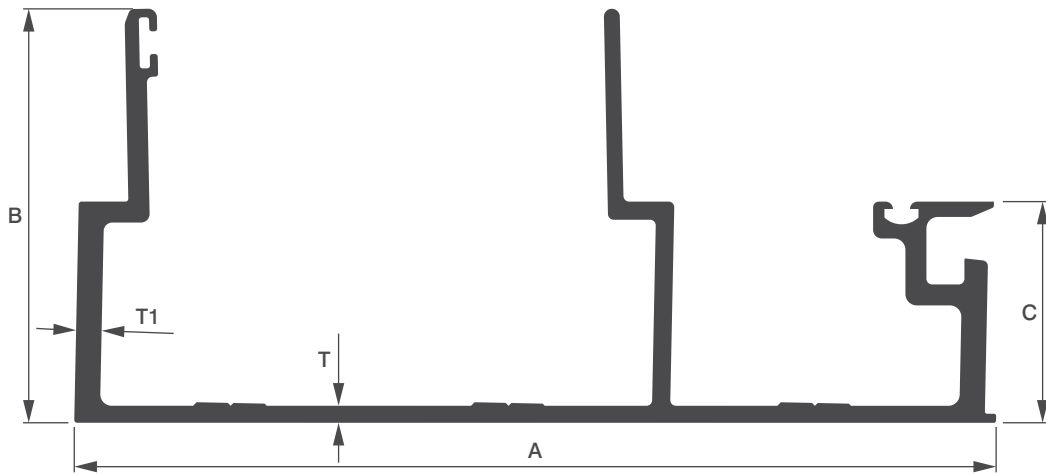

Sl. No.	Sec. No.	A	B	C	T	T1	Wt. Range KG/12'
1	7864	162.50	72.90	39.00	3.00	4.50	12.950 - 13.450

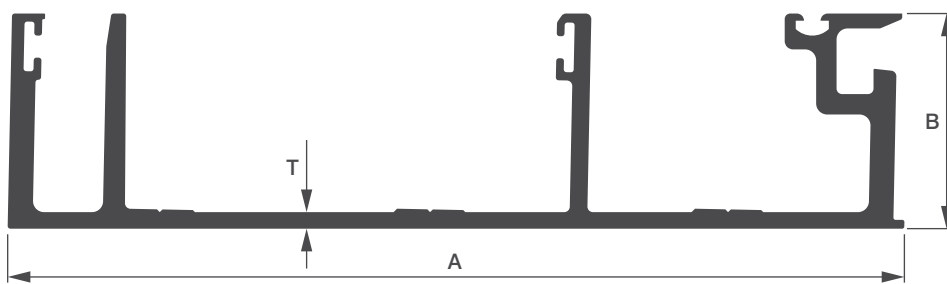

Sl. No.	Sec. No.	A	B	T	Wt. Range KG/12'
1	7865	162.50	39.00	3.00	11.550 - 11.950

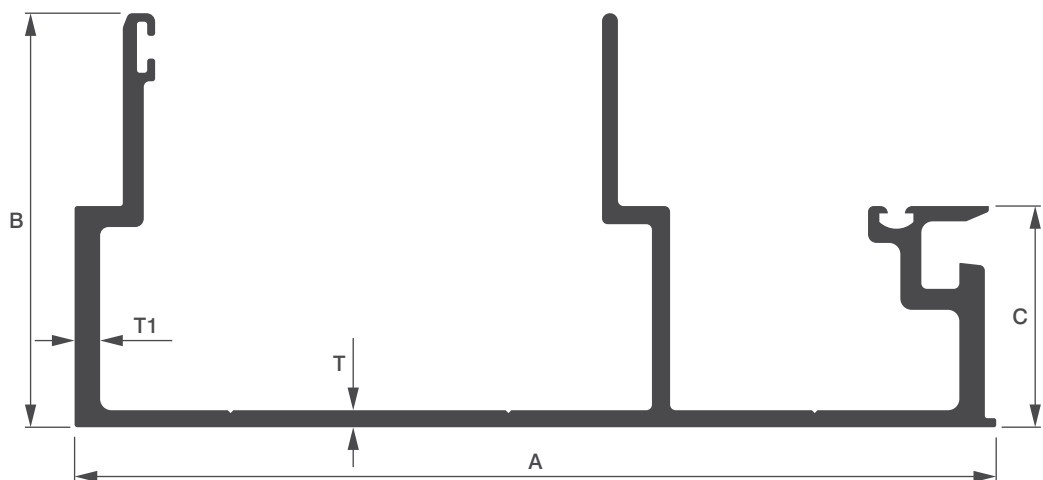

Sl. No.	Sec. No.	A	B	C	T	T1	Wt. Range KG/12'
1	7866	162.50	73.00	39.00	3.00	4.50	12.800 - 13.300



UNITIZED SYSTEMS

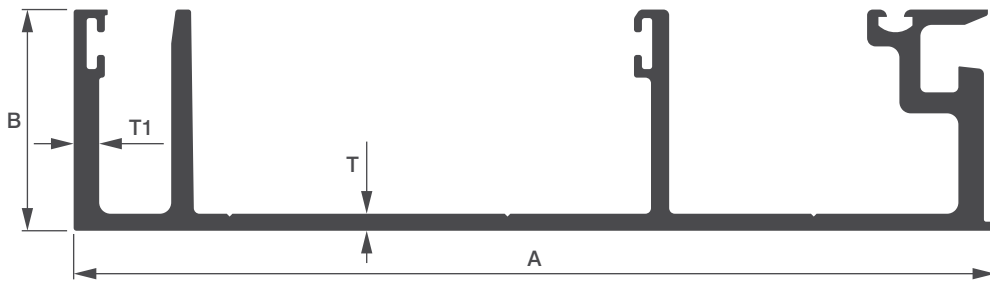

Sl. No.	Sec. No.	A	B	T	T1	Wt. Range KG/12'
1	7867	162.50	39.00	3.00	4.50	11.400 - 11.800

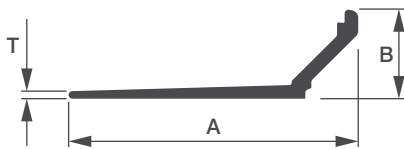

Sl. No.	Sec. No.	A	B	T	Wt. Range KG/12'
1	7868	38.30	11.85	1.00	0.650 - 0.950

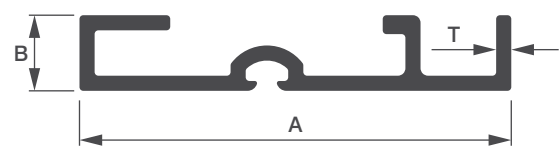

Sl. No.	Sec. No.	A	B	T	Wt. Range KG/12'
1	7874	57.10	10.00	2.00	2.000 - 2.300

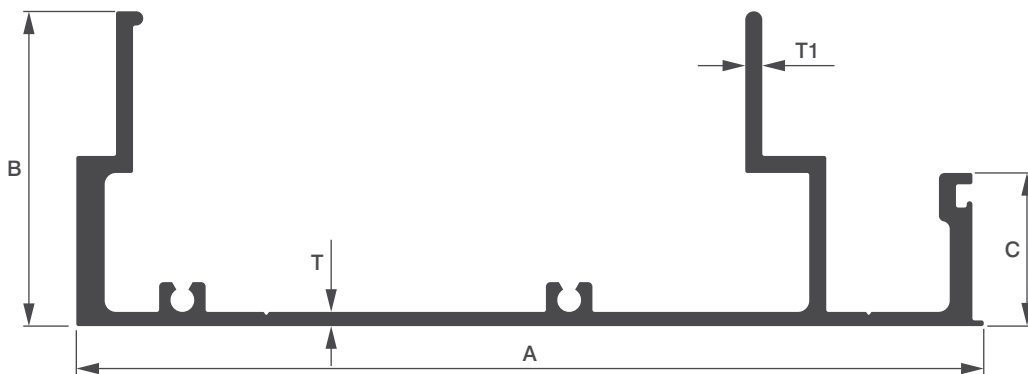

Sl. No.	Sec. No.	A	B	C	T	T1	Wt. Range KG/12'
1	7869	160.00	55.50	27.00	2.50	3.00	9.650 - 10.150

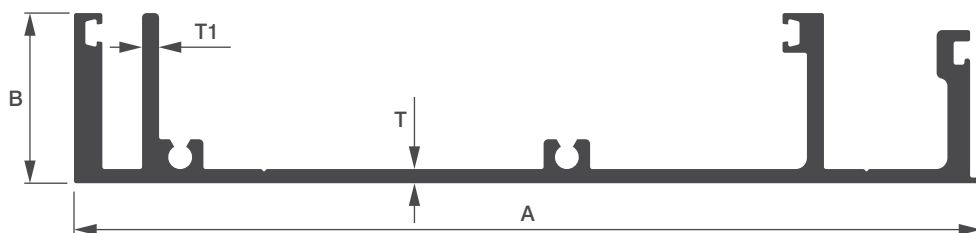

Sl. No.	Sec. No.	A	B	T	T1	Wt. Range KG/12'
1	7870	160.00	30.00	2.50	3.00	8.450 - 8.850



UNITIZED SYSTEMS

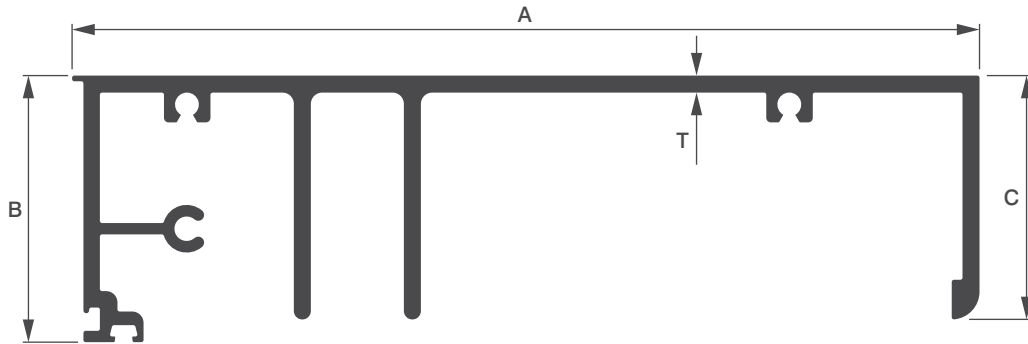

Sl. No.	Sec. No.	A	B	C	T	Wt. Range KG/12'
1	7871	160.00	47.00	43.00	3.00	10.900 - 11.500

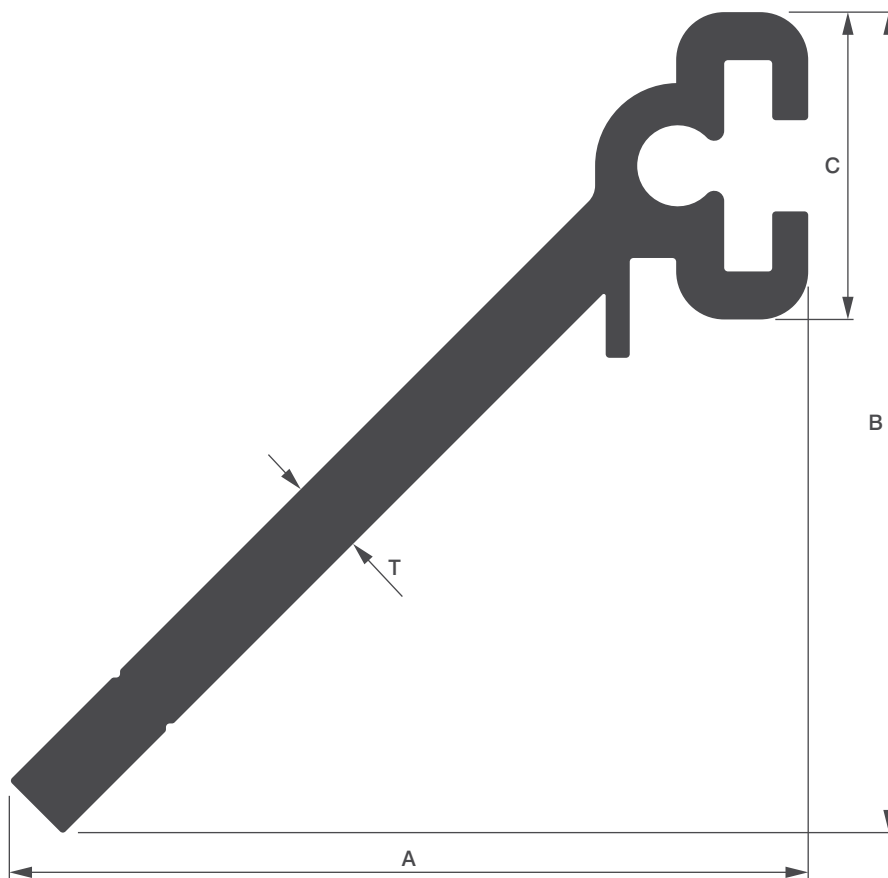

Sl. No.	Sec. No.	A	B	C	T	Wt. Range KG/12'
1	7877	105.65	108.50	40.64	10.00	16.350 - 16.750



UNITIZED SYSTEMS

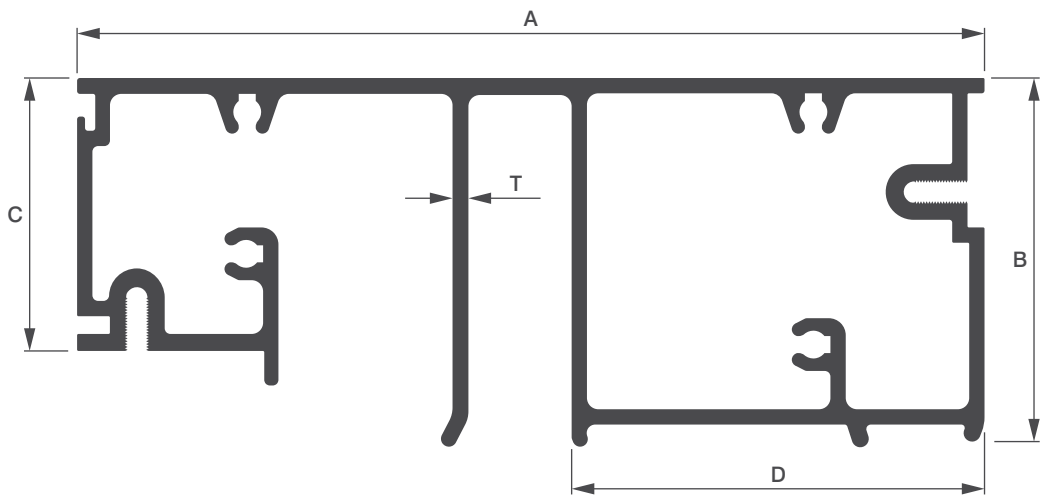

Sl. No.	Sec. No.	A	B	C	D	T	Wt. Range KG/12'
1	7875	120.00	48.08	36.09	54.60	2.10	17.500 - 17.900

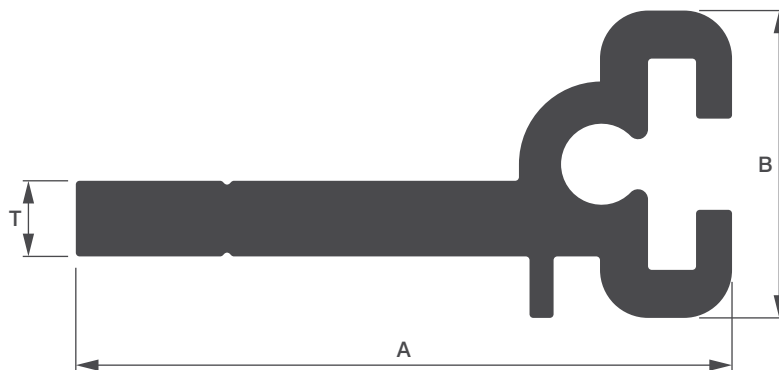

Sl. No.	Sec. No.	A	B	T	Wt. Range KG/12'
1	7876	86.80	40.60	10.00	11.600 - 11.950

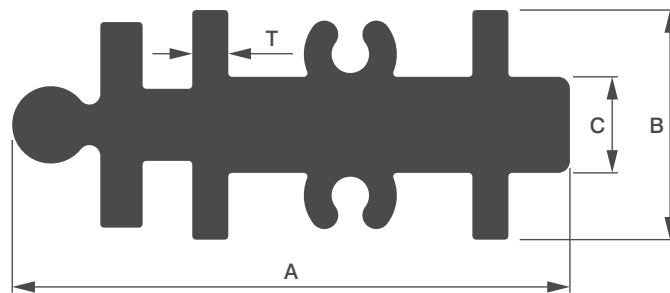

Sl. No.	Sec. No.	A	B	C	T	Wt. Range KG/12'
1	7878	73.75	30.36	12.70	4.76	10.450 - 10.900



UNITIZED SYSTEMS

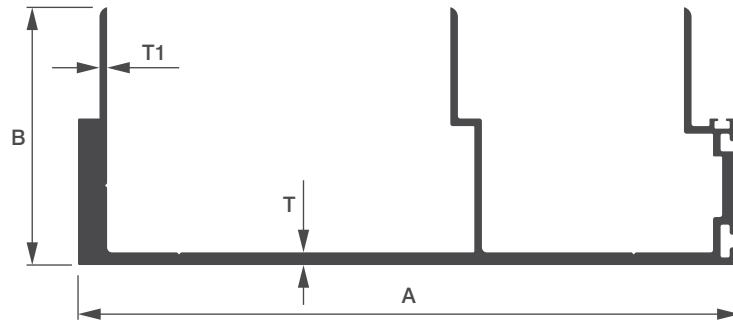

Sl. No.	Sec. No.	A	B	T	T1	Wt. Range KG/12'
1	8001	131.00	51.00	2.50	1.50	6.900 - 7.500

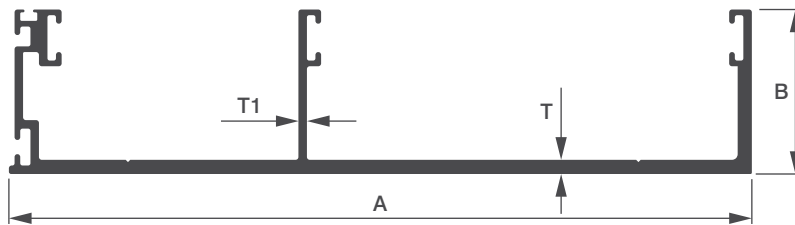

Sl. No.	Sec. No.	A	B	T	T1	Wt. Range KG/12'
1	8002	131.00	29.00	2.50	1.50	5.000 - 5.600

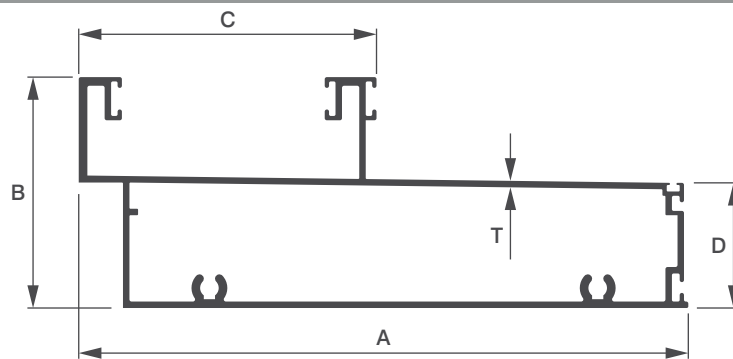

Sl. No.	Sec. No.	A	B	C	D	T	Wt. Range KG/12'
1	8003	141.25	53.50	69.00	29.00	1.50	7.000 - 7.600

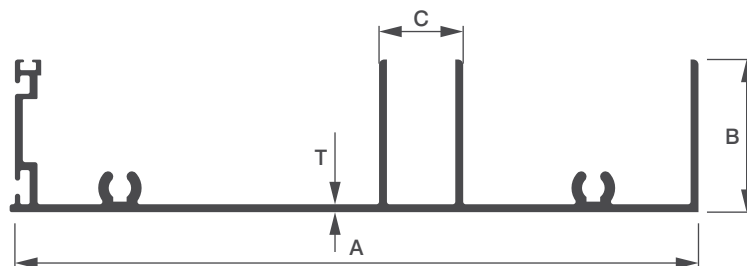

Sl. No.	Sec. No.	A	B	C	T	Wt. Range KG/12'
1	8004	130.00	29.00	16.00	1.50	5.000 - 5.600



UNITIZED SYSTEMS

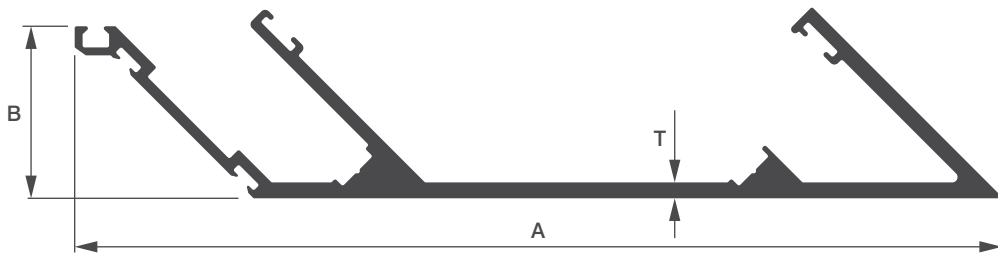

Sl. No.	Sec. No.	A	B	T	Wt. Range KG/12'
1	7815	175.20	32.50	3.00	8.500 - 8.900

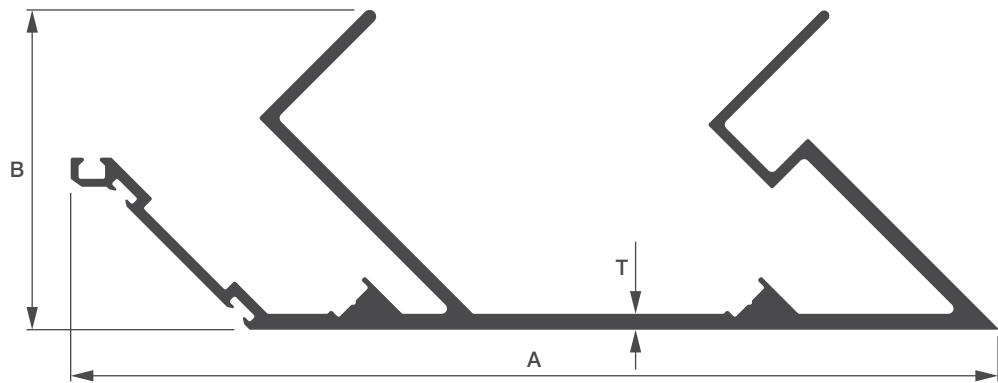

Sl. No.	Sec. No.	A	B	T	Wt. Range KG/12'
1	7816	175.20	60.40	3.00	21.400 - 22.200

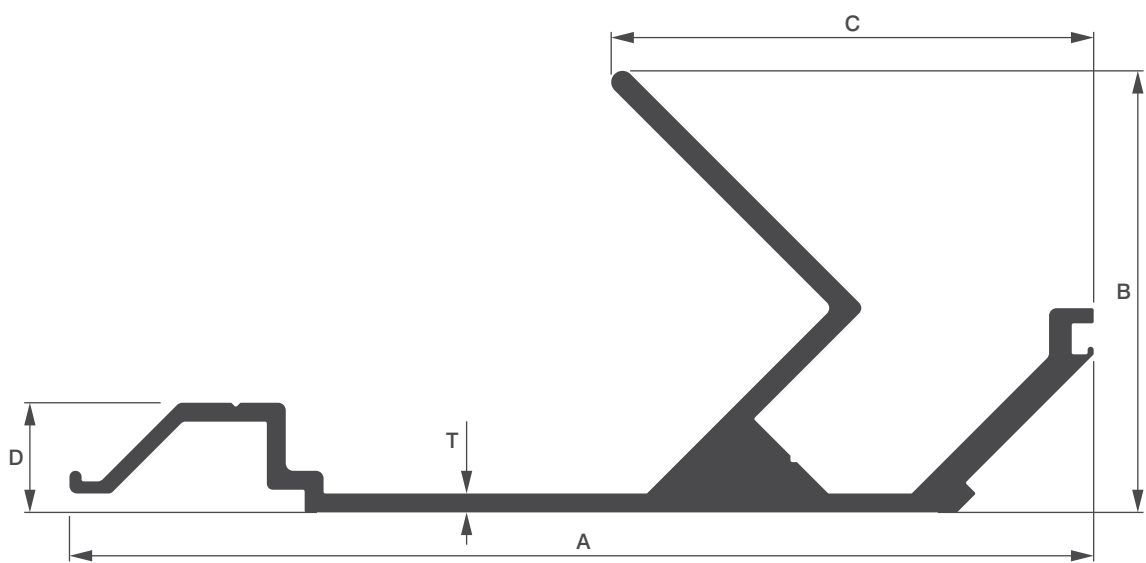

Sl. No.	Sec. No.	A	B	C	D	T	Wt. Range KG/12'
1	7853	135.45	58.40	63.80	14.50	2.50	7.800 - 8.300



UNITIZED SYSTEMS

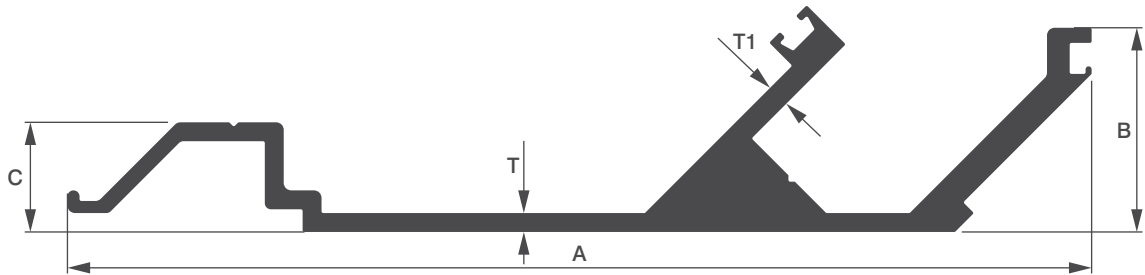

Sl. No.	Sec. No.	A	B	C	T	T1	Wt. Range KG/12'
1	7854	135.44	27.00	14.50	2.50	3.00	6.600 - 7.400

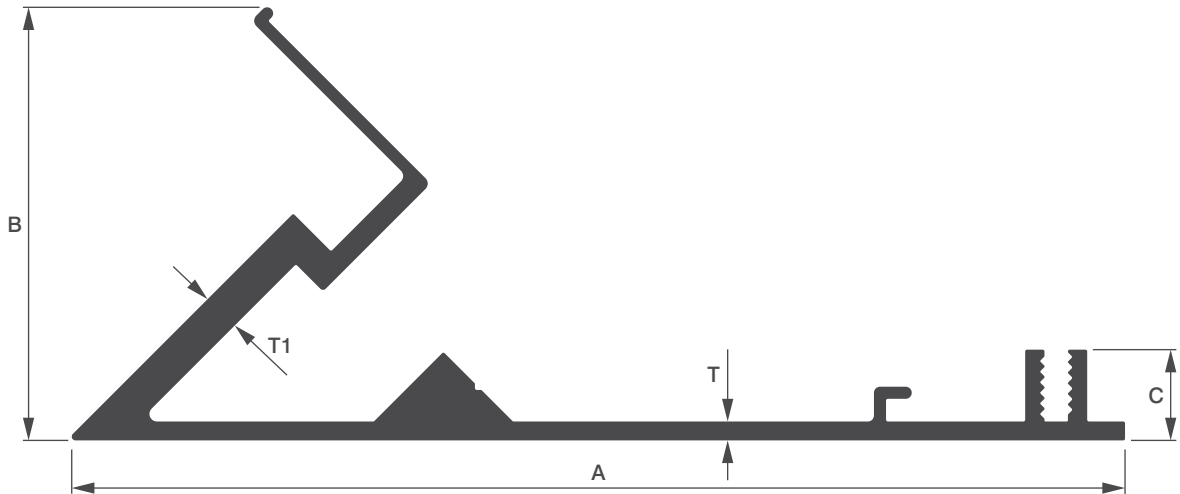

Sl. No.	Sec. No.	A	B	C	T	T1	Wt. Range KG/12'
1	7855	140.00	57.27	12.00	2.50	5.00	7.700 - 8.700

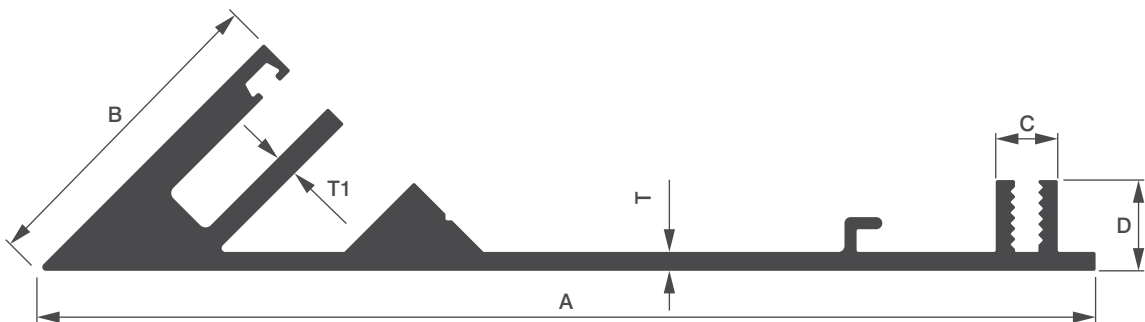

Sl. No.	Sec. No.	A	B	C	D	T	T1	Wt. Range KG/12'
1	7856/R	140.00	42.43	8.20	12.00	2.50	3.00	7.700 - 8.300