

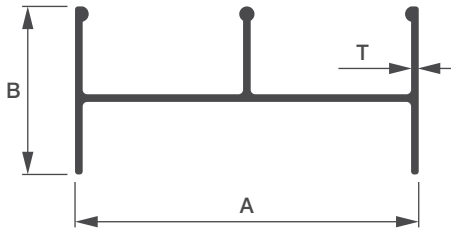

SLIDING WINDOWS

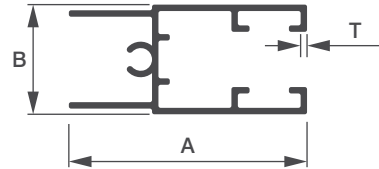

Sl. No.	Sec. No.	A	B	T	Wt. Range KG/12'
1	1803	45.00	22.00	1.00	1.000 - 1.200



Sl. No.	Sec. No.	A	B	T	Wt. Range KG/12'
1	1807	31.50	14.50	0.85	0.900 - 1.100

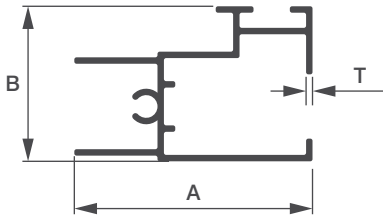

Sl. No.	Sec. No.	A	B	T	Wt. Range KG/12'
1	1808	31.50	20.50	0.85	0.950 - 1.150

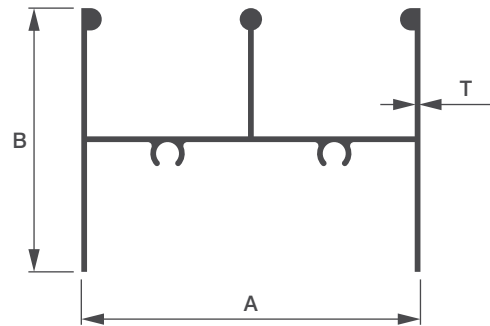

Sl. No.	Sec. No.	A	B	T	Wt. Range KG/12'
1	1809	45.00	35.00	0.85	1.200 - 1.450
2	1809/H	45.00	35.00	1.20	1.600 - 1.900
3	1859	45.00	35.00	1.50	2.200 - 2.500

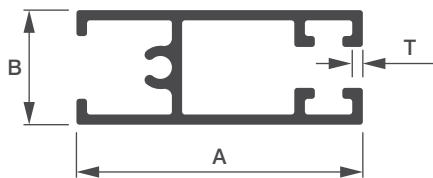

Sl. No.	Sec. No.	A	B	T	Wt. Range KG/12'
1	1810/L	37.50	15.00	0.85	1.000 - 1.250
2	1810	37.50	15.00	1.15	1.300 - 1.500
3	1810/H	37.50	15.00	1.40	1.600 - 1.900

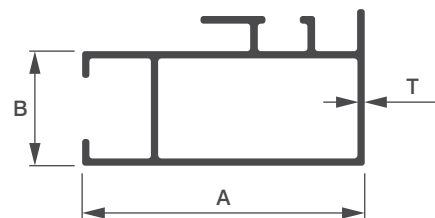

Sl. No.	Sec. No.	A	B	T	Wt. Range KG/12'
1	1811/L	37.50	15.00	0.80	1.000 - 1.250
2	1811	37.50	15.00	1.10	1.300 - 1.500
3	1811/H	37.50	15.00	1.35	1.600 - 1.900



SLIDING WINDOWS

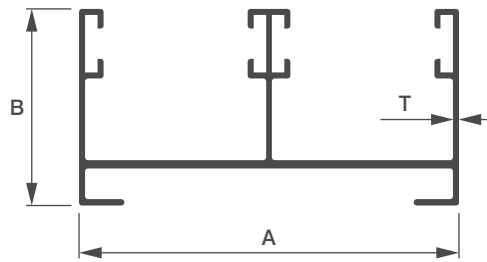

Sl. No.	Sec. No.	A	B	T	Wt. Range KG/12'
1	7295	50.25	26.00	0.80	1.400 - 1.600

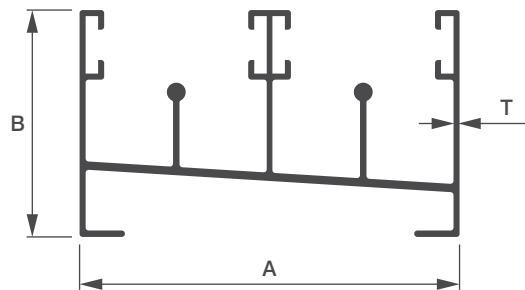

Sl. No.	Sec. No.	A	B	T	Wt. Range KG/12'
1	7296	50.25	30.00	0.80	1.750 - 1.900

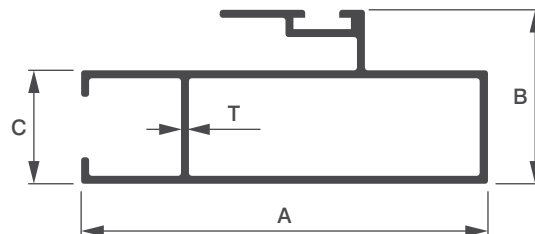

Sl. No.	Sec. No.	A	B	C	T	Wt. Range KG/12'
1	7298	53.80	23.00	15.00	1.05	1.750 - 1.900

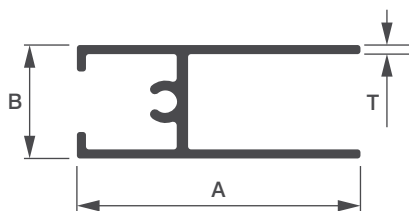

Sl. No.	Sec. No.	A	B	T	Wt. Range KG/12'
1	7299	37.50	15.00	1.20	1.200 - 1.300

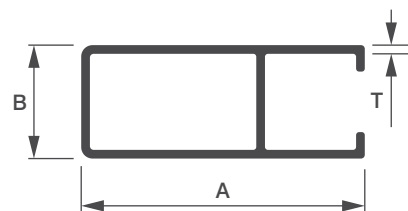

Sl. No.	Sec. No.	A	B	T	Wt. Range KG/12'
1	7297	37.50	15.00	1.15	1.150 - 1.300



SLIDING WINDOWS

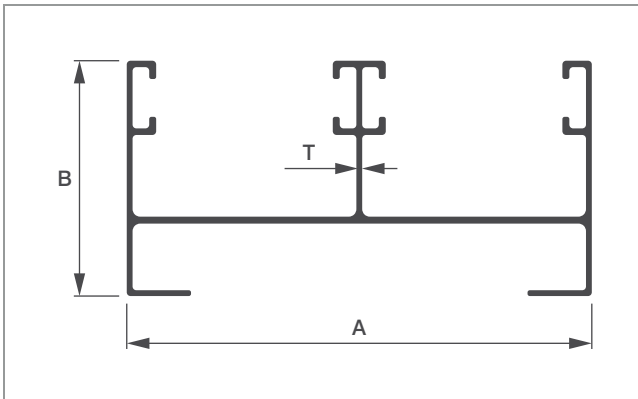

Sl. No.	Sec. No.	A	B	T	Wt. Range KG/12'
1	1812	62.00	31.50	1.00	1.700 - 2.000
2	1812/H	62.00	31.50	1.10	2.050 - 2.300
3	1813	62.00	31.50	1.30	2.500 - 2.800

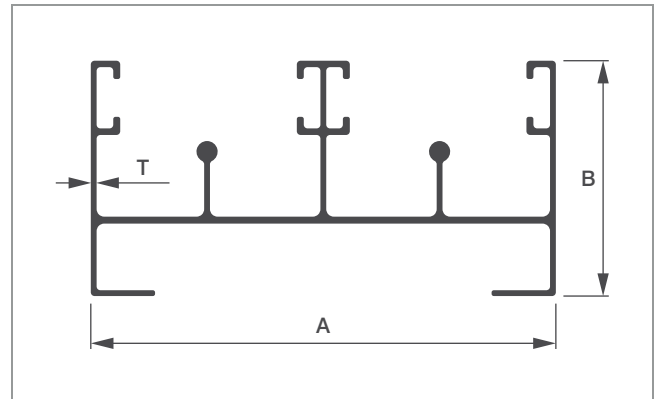

Sl. No.	Sec. No.	A	B	T	Wt. Range KG/12'
1	1814	62.00	31.50	0.90	1.800 - 2.100
2	1814/H	62.00	31.50	1.15	2.150 - 2.350
3	1815	62.00	31.50	1.30	2.550 - 2.850

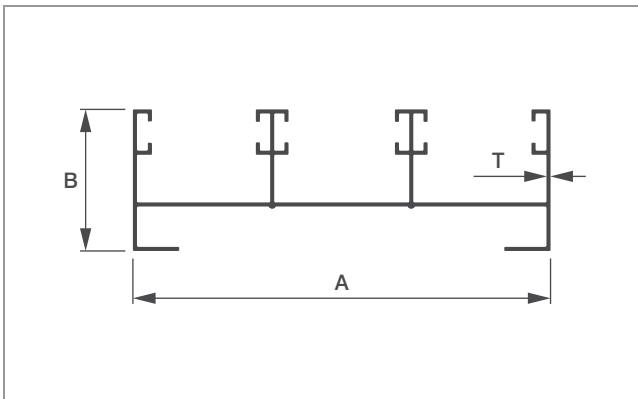

Sl. No.	Sec. No.	A	B	T	Wt. Range KG/12'
1	1817	92.00	31.50	0.95	2.600 - 2.900
2	1817/H	92.00	31.50	1.40	3.600 - 3.900

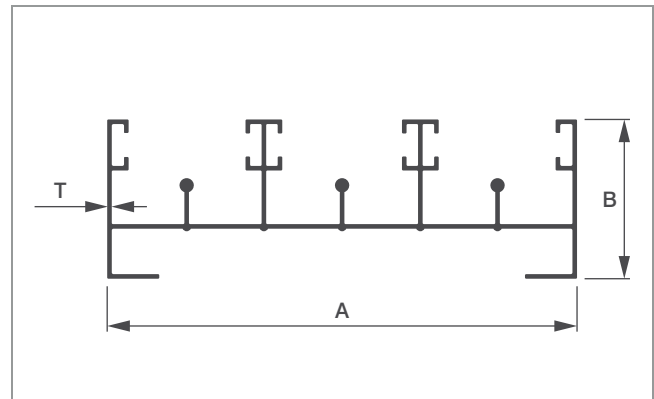

Sl. No.	Sec. No.	A	B	T	Wt. Range KG/12'
1	1818	92.00	31.50	0.90	2.700 - 3.000
2	1818/H	92.00	31.50	1.40	3.600 - 4.000

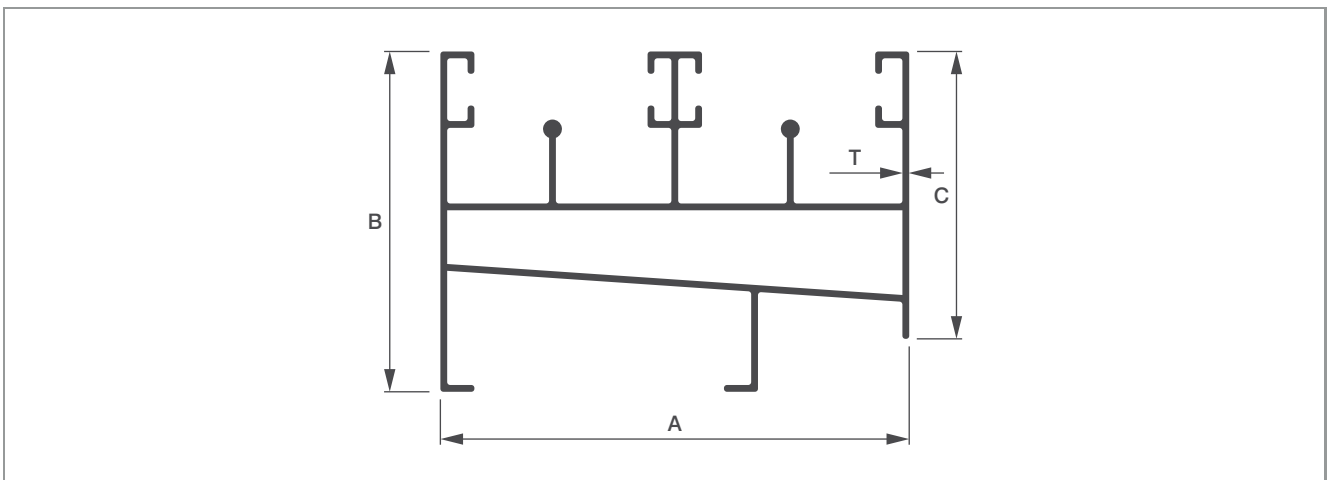

Sl. No.	Sec. No.	A	B	C	T	Wt. Range KG/12'
1	1816	62.00	37.00	31.50	1.00	3.000 - 3.500
2	1833	62.00	45.00	37.00	1.15	3.750 - 4.100



SLIDING WINDOWS

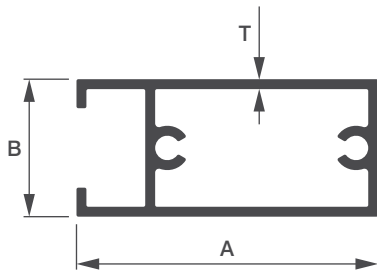

Sl. No.	Sec. No.	A	B	T	Wt. Range KG/12'
1	1804	40.00	18.00	0.65	0.850 - 1.000
2	1805	40.00	18.00	0.75	1.010 - 1.200
3	1819	40.00	18.00	0.90	1.210 - 1.450
4	1819/H	40.00	18.00	1.20	1.460 - 1.600
5	1820	40.00	18.00	1.40	1.800 - 2.00

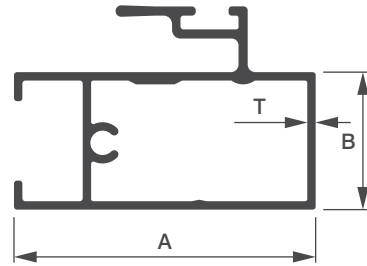

Sl. No.	Sec. No.	A	B	T	Wt. Range KG/12'
1	1806	40.00	18.00	0.55	0.900 - 1.100
2	1821	40.00	18.00	0.85	1.110 - 1.400
3	1821/H	40.00	18.00	1.00	1.500 - 1.700
4	1822	40.00	18.00	1.20	1.800 - 2.100

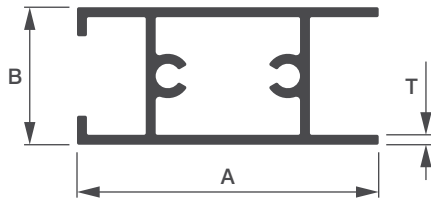

Sl. No.	Sec. No.	A	B	T	Wt. Range KG/12'
1	1801	40.00	18.00	0.65	0.850 - 1.000
2	1802	40.00	18.00	0.75	1.010 - 1.200
3	1823	40.00	18.00	0.85	1.210 - 1.450
4	1823/H	40.00	18.00	1.20	1.400 - 1.600
5	1824	40.00	18.00	1.40	1.800 - 2.000

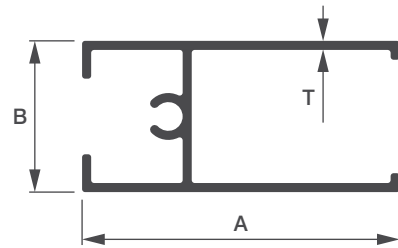

Sl. No.	Sec. No.	A	B	T	Wt. Range KG/12'
1	1839/L	42.00	20.00	1.10	1.200 - 1.500
2	1839	42.00	20.00	1.20	1.500 - 1.800

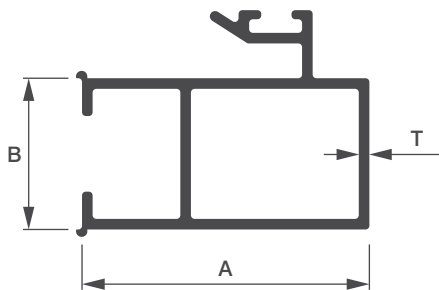

Sl. No.	Sec. No.	A	B	T	Wt. Range KG/12'
1	1837/L	38.00	20.00	0.90	1.300 - 1.600
2	1837	38.00	20.00	1.50	2.000 - 2.300

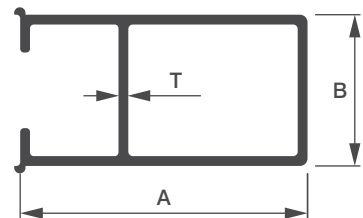

Sl. No.	Sec. No.	A	B	T	Wt. Range KG/12'
1	1836/L	38.00	20.00	0.90	1.000 - 1.300
2	1836	38.00	20.00	1.45	1.650 - 2.000
3	7903	45.80	20.10	0.60	0.900 - 1.200



SLIDING WINDOWS

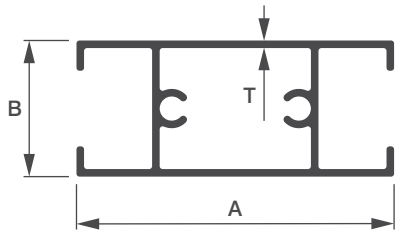

Sl. No.	Sec. No.	A	B	T	Wt. Range KG/12'
1	8896	42.00	18.00	1.00	1.400 - 1.700

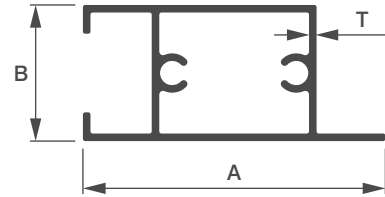

Sl. No.	Sec. No.	A	B	T	Wt. Range KG/12'
1	8897	40.00	18.00	1.00	1.200 - 1.500

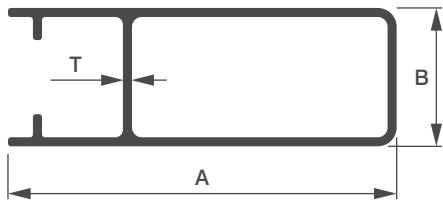

Sl. No.	Sec. No.	A	B	T	Wt. Range KG/12'
1	1828	51.40	18.30	1.20	1.600 - 1.900

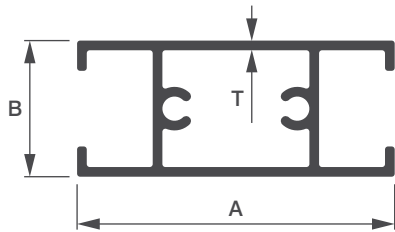

Sl. No.	Sec. No.	A	B	T	Wt. Range KG/12'
1	8863	42.00	18.00	1.28	1.800 - 2.000

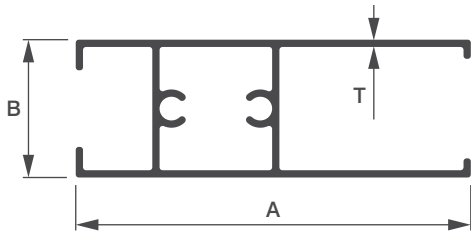

Sl. No.	Sec. No.	A	B	T	Wt. Range KG/12'
1	8836	51.60	18.00	0.95	1.500 - 1.600

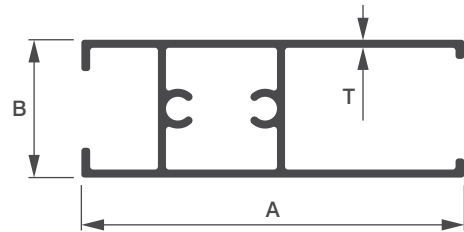

Sl. No.	Sec. No.	A	B	T	Wt. Range KG/12'
1	8861	50.00	18.00	1.05	1.650 - 1.700

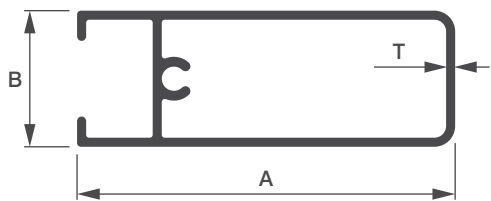

Sl. No.	Sec. No.	A	B	T	Wt. Range KG/12'
1	8859	50.00	18.00	1.20	1.700 - 1.850

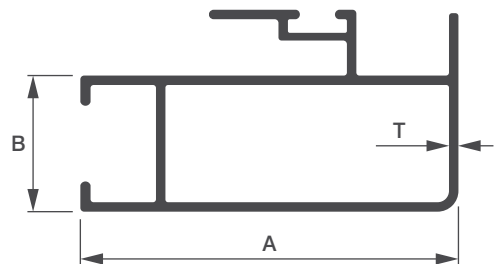

Sl. No.	Sec. No.	A	B	T	Wt. Range KG/12'
1	8860	50.00	18.00	1.25	2.150 - 2.350



SLIDING WINDOWS

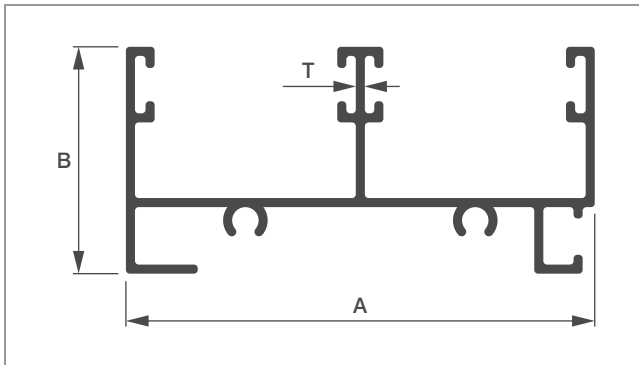

Sl. No.	Sec. No.	A	B	T	Wt. Range KG/12'
1	1831/L	62.00	30.00	0.95	1.900 - 2.300
2	1831	62.00	30.00	1.30	2.600 - 2.900
3	1831/H	62.00	30.00	1.50	3.100 - 3.300

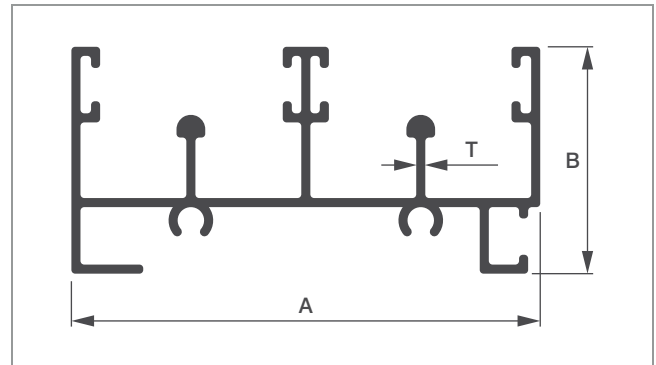

Sl. No.	Sec. No.	A	B	T	Wt. Range KG/12'
1	1832/L	62.00	30.00	0.85	1.900 - 2.300
2	1832	62.00	30.00	1.15	2.700 - 3.000
3	1832/H	62.00	30.00	1.35	3.200 - 3.400

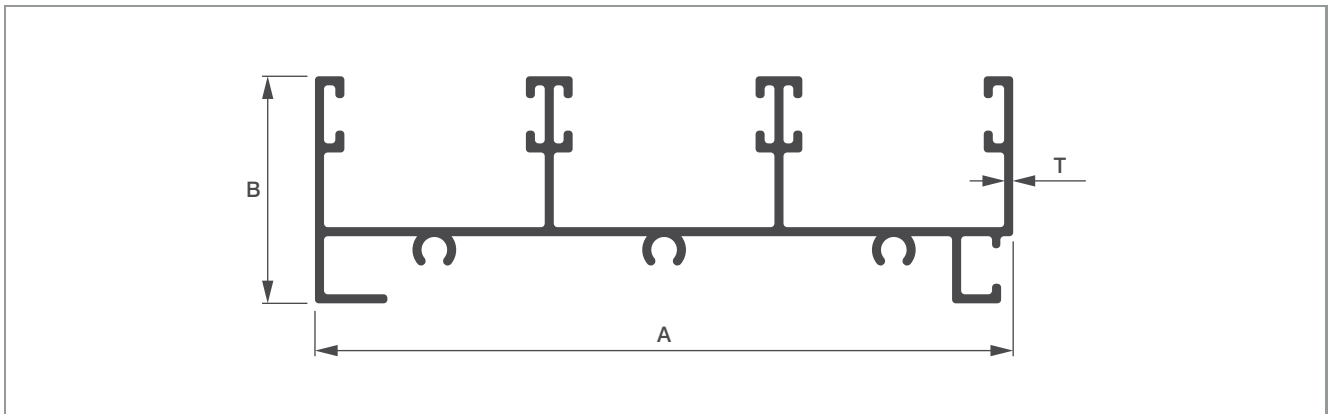

Sl. No.	Sec. No.	A	B	T	Wt. Range KG/12'
1	1834/L	92.50	30.00	1.20	3.200 - 3.500
2	1834	92.50	30.00	1.35	3.600 - 4.000
3	1834/H	92.50	30.00	1.90	4.200 - 4.400

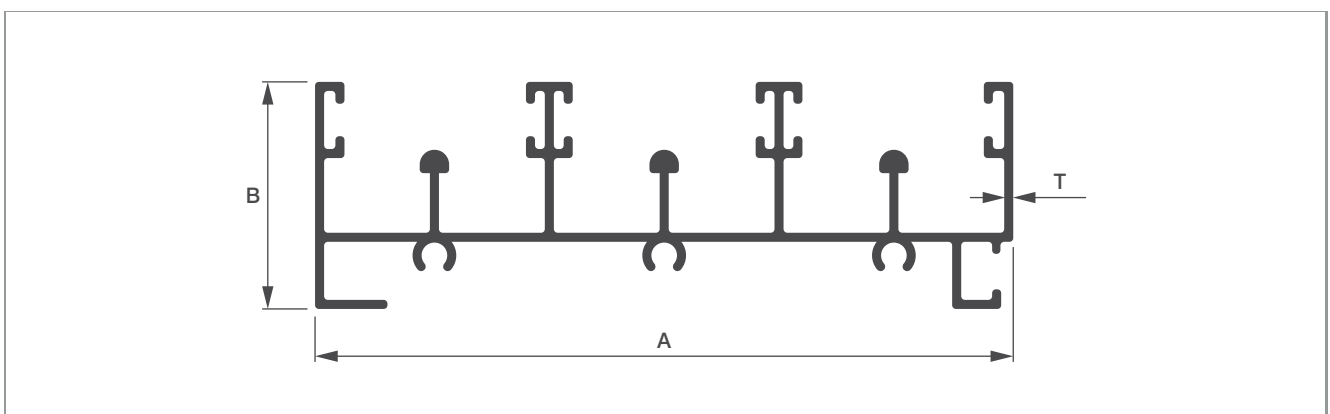

Sl. No.	Sec. No.	A	B	T	Wt. Range KG/12'
1	1835/L	92.50	30.00	1.10	3.400 - 3.600
2	1835	92.50	30.00	1.35	3.800 - 4.200
3	1835/H	92.50	30.00	1.45	4.250 - 4.450



SLIDING WINDOWS

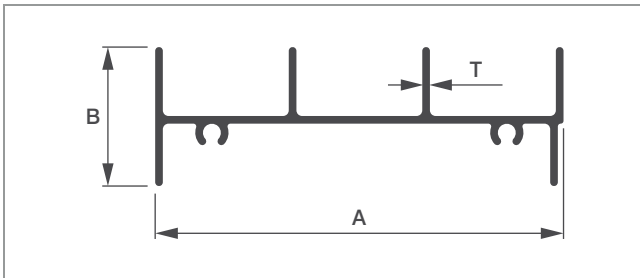

Sl. No.	Sec. No.	A	B	T	Wt. Range KG/12'
1	1851	72.00	24.50	1.35	2.200 - 2.500

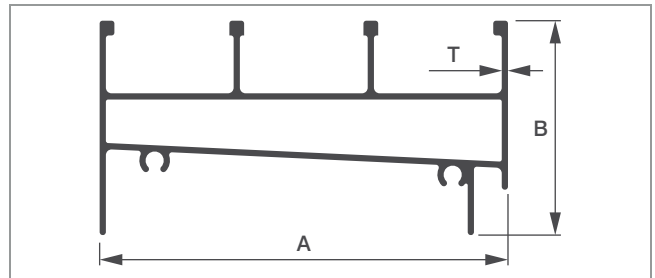

Sl. No.	Sec. No.	A	B	T	Wt. Range KG/12'
1	1852	72.00	37.80	1.10	3.200 - 3.600

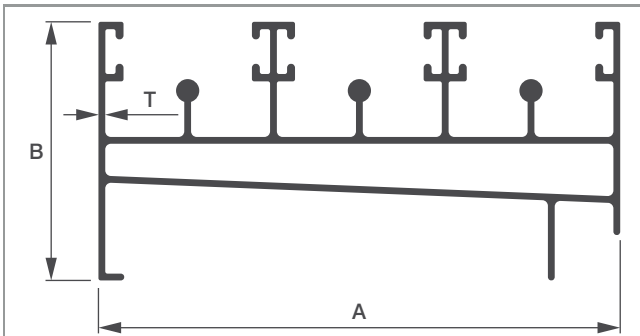

Sl. No.	Sec. No.	A	B	T	Wt. Range KG/12'
1	1853/L	92.00	45.60	1.10	4.800 - 5.000
2	1853	92.00	45.60	1.30	5.700 - 6.000

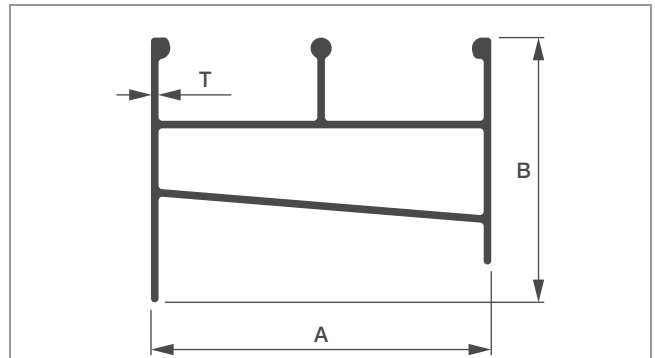

Sl. No.	Sec. No.	A	B	T	Wt. Range KG/12'
1	1858	45.00	35.00	1.00	1.750 - 2.100

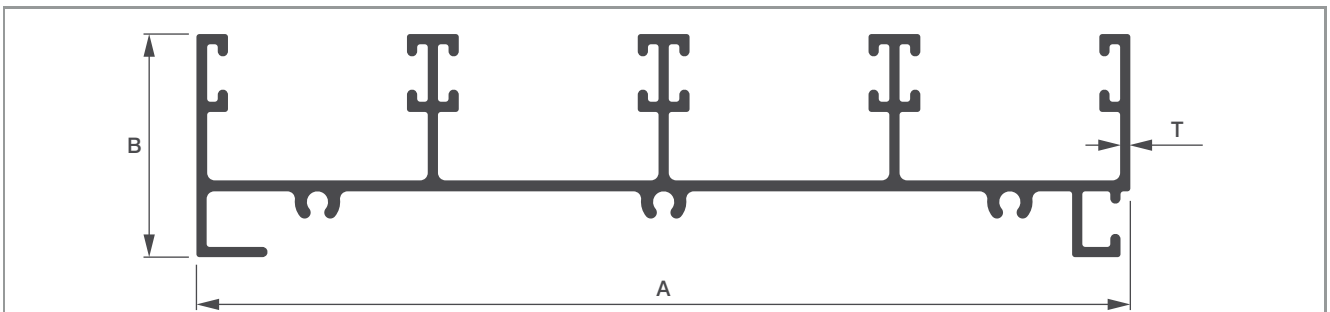

Sl. No.	Sec. No.	A	B	T	Wt. Range KG/12'
1	1856	123.50	29.50	1.35	4.700 - 5.200

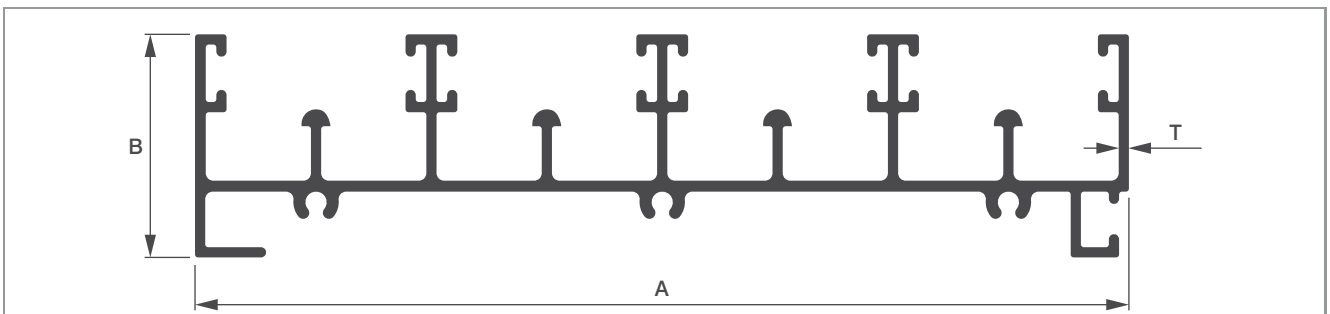

Sl. No.	Sec. No.	A	B	T	Wt. Range KG/12'
1	1857	123.50	29.50	1.45	5.300 - 5.800



SLIDING WINDOWS

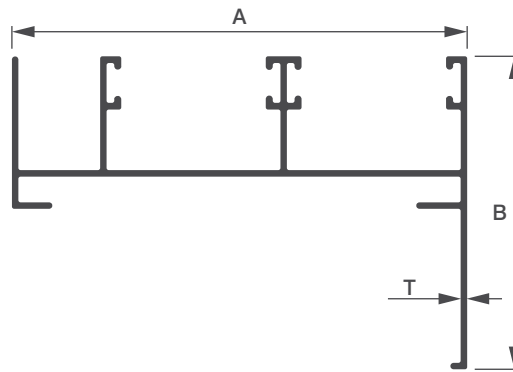

Sl. No.	Sec. No.	A	B	T	Wt. Range KG/12'
1	1826	80.00	55.00	1.15	2.750 - 3.300

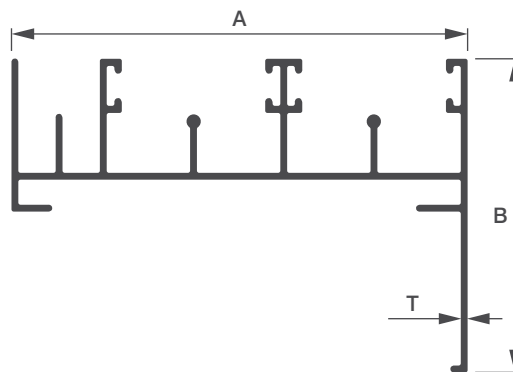

Sl. No.	Sec. No.	A	B	T	Wt. Range KG/12'
1	1827	80.00	55.00	1.20	3.200 - 3.500

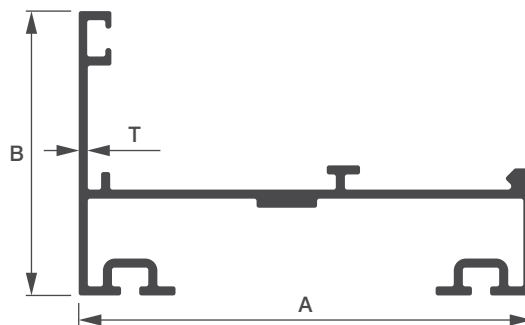

Sl. No.	Sec. No.	A	B	T	Wt. Range KG/12'
1	1829	75.00	47.00	1.50	3.300 - 3.700

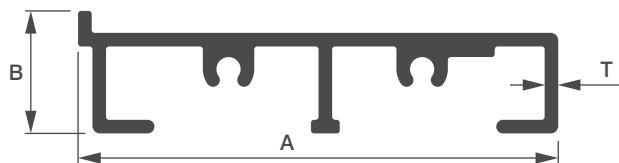

Sl. No.	Sec. No.	A	B	T	Wt. Range KG/12'
1	4128	63.50	16.20	1.80	2.610 - 2.885



SLIDING WINDOWS

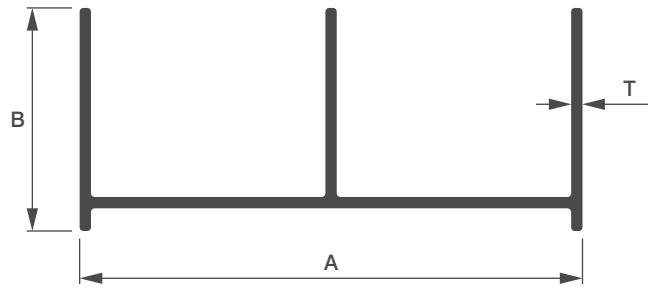

Sl. No.	Sec. No.	A	B	T	Wt. Range KG/12'
1	1861	66.50	29.50	1.50	2.200 - 2.400

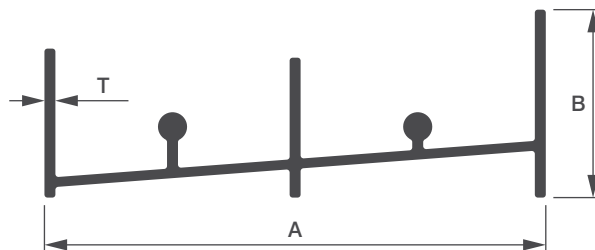

Sl. No.	Sec. No.	A	B	T	Wt. Range KG/12'
1	1862	66.30	24.85	1.45	2.000 - 2.200

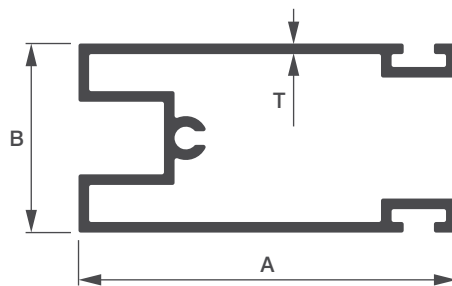

Sl. No.	Sec. No.	A	B	T	Wt. Range KG/12'
1	1863	50.00	25.00	1.40	2.350 - 2.700

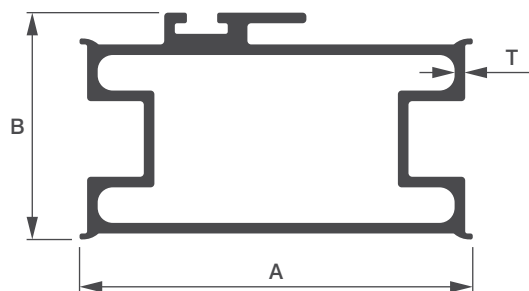

Sl. No.	Sec. No.	A	B	T	Wt. Range KG/12'
1	1864	52.00	30.00	1.40	2.950 - 3.250



SLIDING WINDOWS

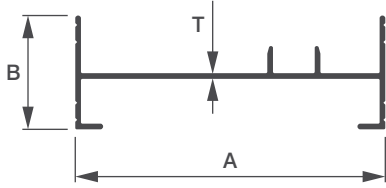

Sl. No.	Sec. No.	A	B	T	Wt. Range KG/12'
1	8817/L	81.70	30.00	1.20	1.930 - 2.200
2	8817	81.70	30.00	1.50	2.400 - 2.650

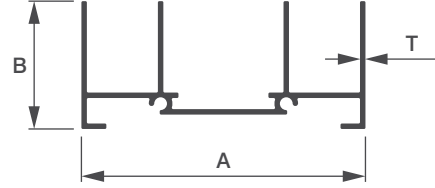

Sl. No.	Sec. No.	A	B	T	Wt. Range KG/12'
1	8818/L	78.00	35.10	1.20	2.600 - 2.900
2	8818	78.00	35.10	1.50	3.350 - 3.700

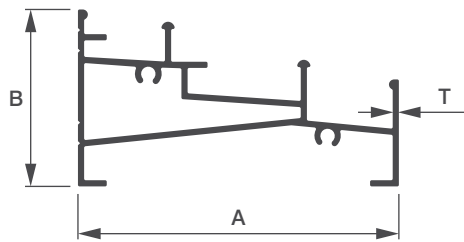

Sl. No.	Sec. No.	A	B	T	Wt. Range KG/12'
1	8816/L	78.00	43.00	1.20	3.100 - 3.400
2	8816	78.00	43.00	1.50	4.050 - 4.450

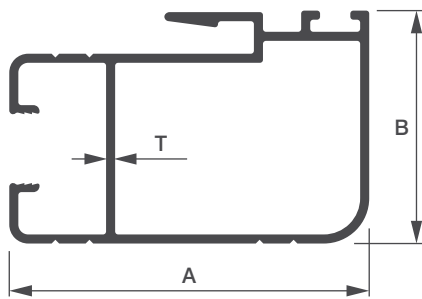

Sl. No.	Sec. No.	A	B	T	Wt. Range KG/12'
1	8819	47.60	30.80	1.20	2.200 - 2.400

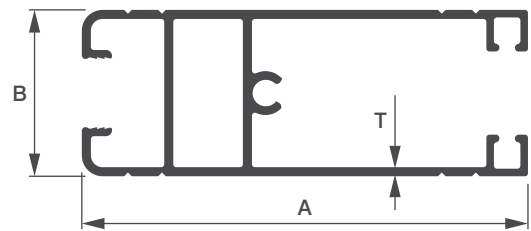

Sl. No.	Sec. No.	A	B	T	Wt. Range KG/12'
1	8820	59.00	22.00	1.20	2.300 - 2.525

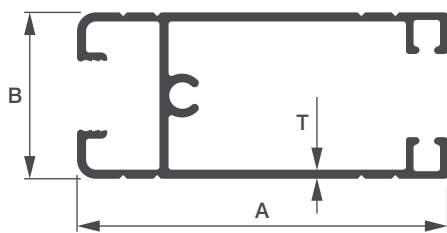

Sl. No.	Sec. No.	A	B	T	Wt. Range KG/12'
1	8821	49.00	22.00	1.20	1.800 - 2.000

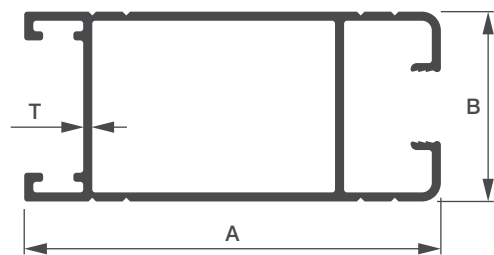

Sl. No.	Sec. No.	A	B	T	Wt. Range KG/12'
1	8822	55.10	25.10	1.20	2.150 - 2.350



SLIDING WINDOWS

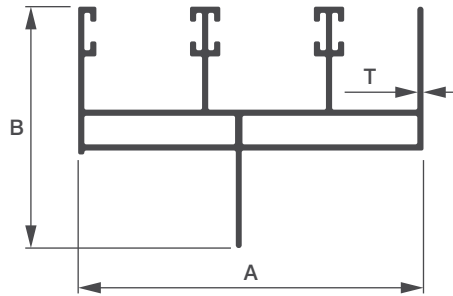

Sl. No.	Sec. No.	A	B	T	Wt. Range KG/12'
1	5101	70.10	48.50	1.20	3.750 - 4.150

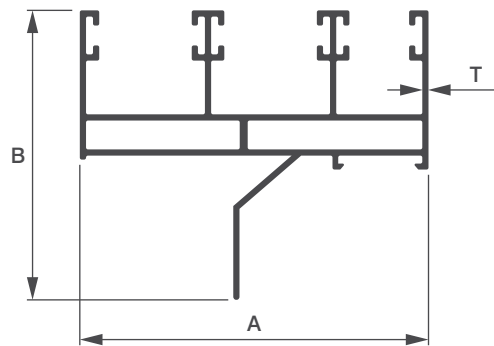

Sl. No.	Sec. No.	A	B	T	Wt. Range KG/12'
1	5102	70.10	58.20	1.25	4.185 - 4.600

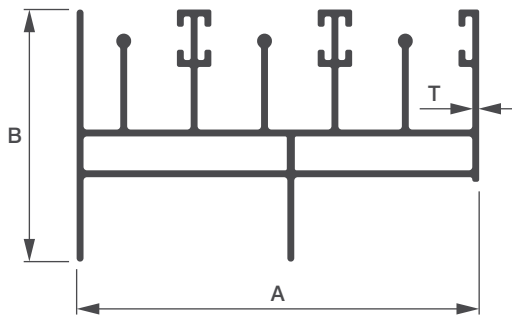

Sl. No.	Sec. No.	A	B	T	Wt. Range KG/12'
1	5103	70.10	43.90	1.20	4.400 - 4.850

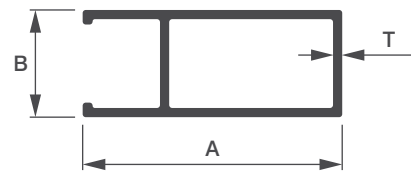

Sl. No.	Sec. No.	A	B	T	Wt. Range KG/12'
1	5107	33.80	14.00	1.20	1.090 - 1.200

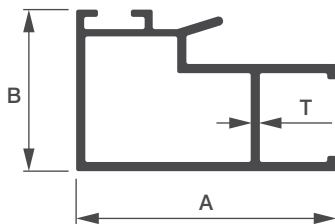

Sl. No.	Sec. No.	A	B	T	Wt. Range KG/12'
1	5108	34.00	21.10	1.20	1.350 - 1.500

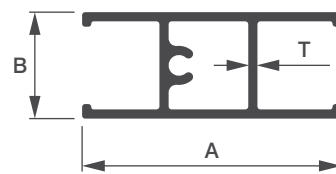

Sl. No.	Sec. No.	A	B	T	Wt. Range KG/12'
1	5109	33.90	13.90	1.20	1.200 - 1.350



SLIDING WINDOWS

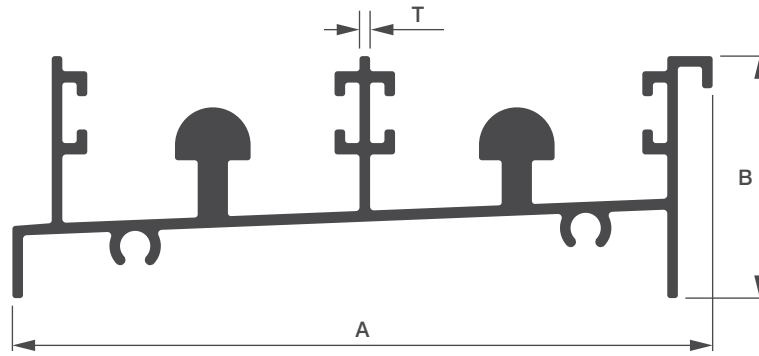

Sl. No.	Sec. No.	A	B	T	Wt. Range KG/12'
1	7453/L	92.60	32.00	1.40	5.000 - 5.500
2	7453	92.60	32.00	2.00	6.300 - 6.700

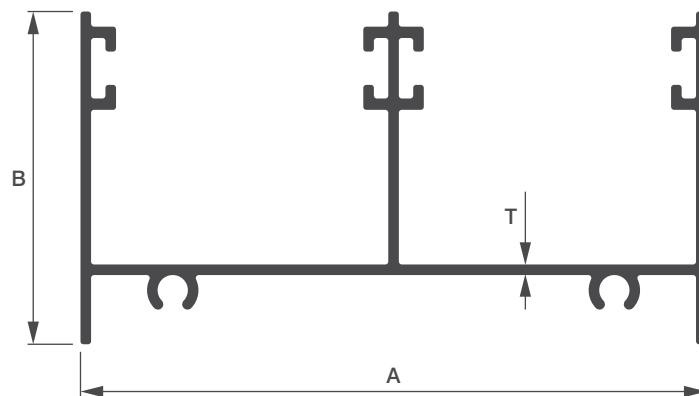

Sl. No.	Sec. No.	A	B	T	Wt. Range KG/12'
1	7454/L	82.80	44.00	1.40	3.650 - 4.100
2	7454	82.80	44.00	1.90	5.100 - 5.500



SLIDING WINDOWS

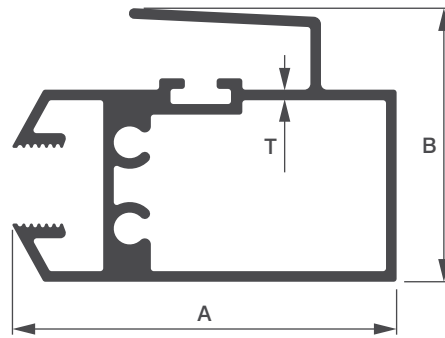

Sl. No.	Sec. No.	A	B	T	Wt. Range KG/12'
1	7455/L	50.80	36.15	1.40	3.450 - 3.750
2	7455	50.80	36.15	1.95	3.700 - 4.000

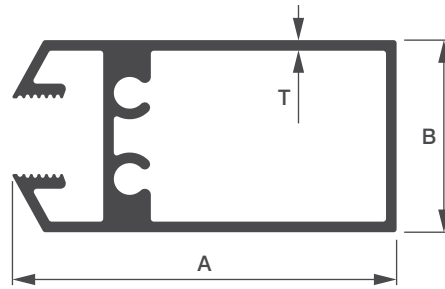

Sl. No.	Sec. No.	A	B	T	Wt. Range KG/12'
1	7456/L	50.80	25.40	1.40	2.800 - 3.100
2	7456	50.80	25.40	1.95	3.000 - 3.300

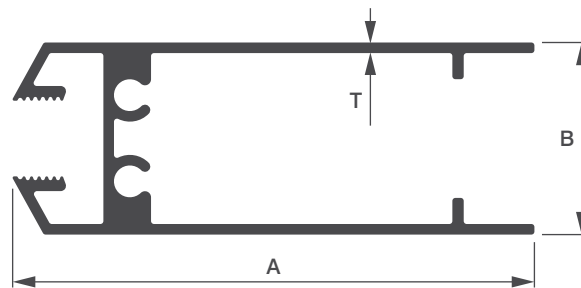

Sl. No.	Sec. No.	A	B	T	Wt. Range KG/12'
1	7457/L	69.00	25.40	1.40	3.100 - 3.500
2	7457	69.00	25.40	1.95	3.700 - 4.000



SLIDING WINDOWS

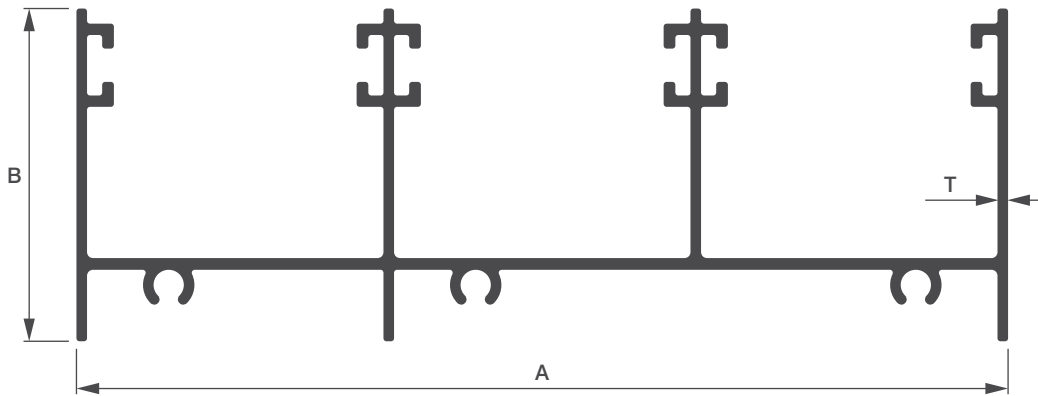

Sl. No.	Sec. No.	A	B	T	Wt. Range KG/12'
1	7473	123.20	44.00	1.40	5.400 - 5.900

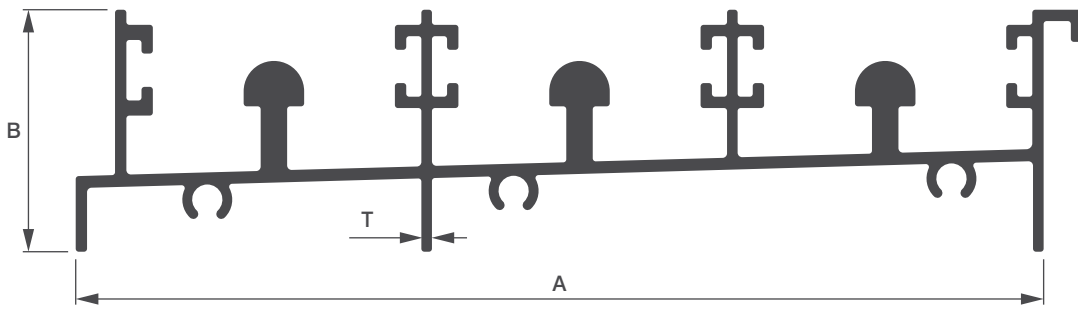

Sl. No.	Sec. No.	A	B	T	Wt. Range KG/12'
1	7474	128.00	32.00	1.40	7.000 - 7.400

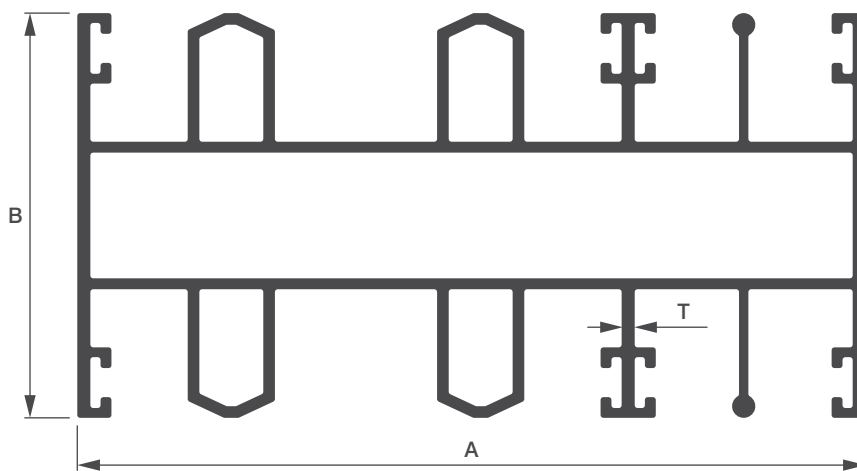

Sl. No.	Sec. No.	A	B	T	Wt. Range KG/12'
1	7603	108.52	55.70	1.80	9.700 - 10.200



SLIDING WINDOWS

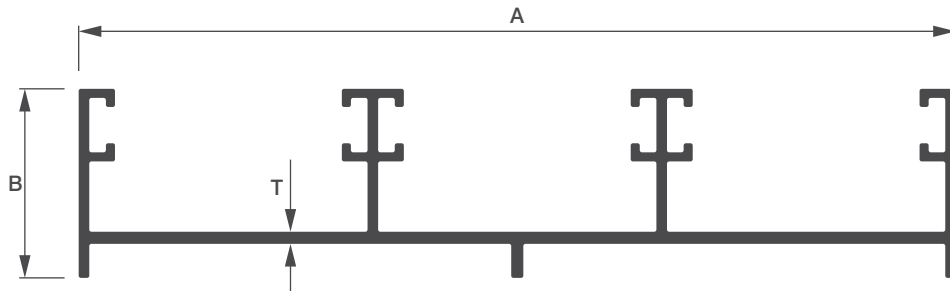

Sl. No.	Sec. No.	A	B	T	Wt. Range KG/12'
1	8891	116.00	25.00	1.60	3.700 - 4.100

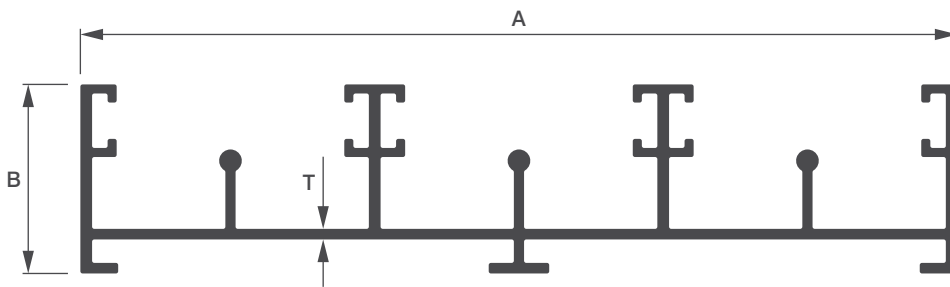

Sl. No.	Sec. No.	A	B	T	Wt. Range KG/12'
1	8892	116.00	25.00	1.40	4.300 - 4.800

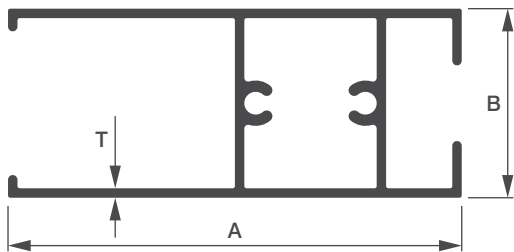

Sl. No.	Sec. No.	A	B	T	Wt. Range KG/12'
1	8889	60.00	25.00	1.25	2.450 - 2.800

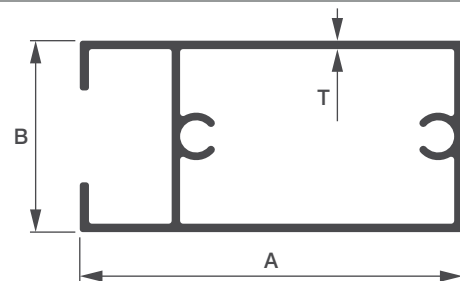

Sl. No.	Sec. No.	A	B	T	Wt. Range KG/12'
1	8837	50.00	25.00	1.10	1.900 - 2.200

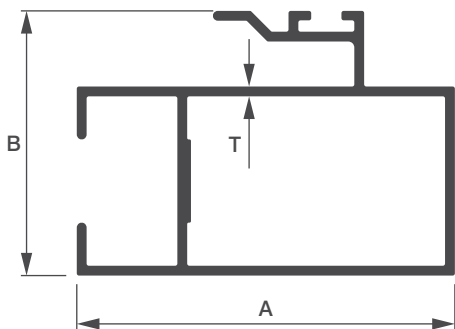

Sl. No.	Sec. No.	A	B	T	Wt. Range KG/12'
1	8888	50.00	35.00	1.30	2.500 - 2.900

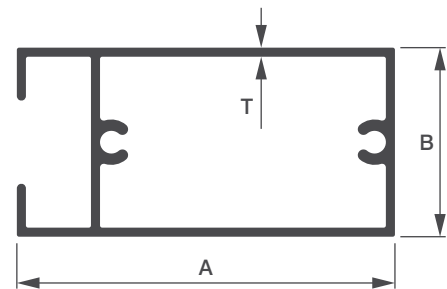

Sl. No.	Sec. No.	A	B	T	Wt. Range KG/12'
1	8890	50.00	25.00	1.20	2.000 - 2.300



SLIDING WINDOWS

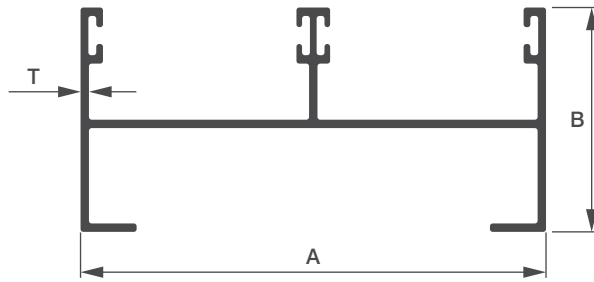

Sl. No.	Sec. No.	A	B	T	Wt. Range KG/12'
1	8801	83.00	40.00	1.50	3.340 - 3.550

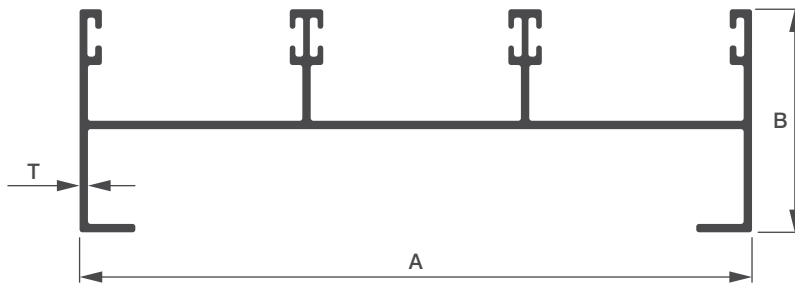

Sl. No.	Sec. No.	A	B	T	Wt. Range KG/12'
1	8802	120.60	40.00	1.50	4.375 - 4.600

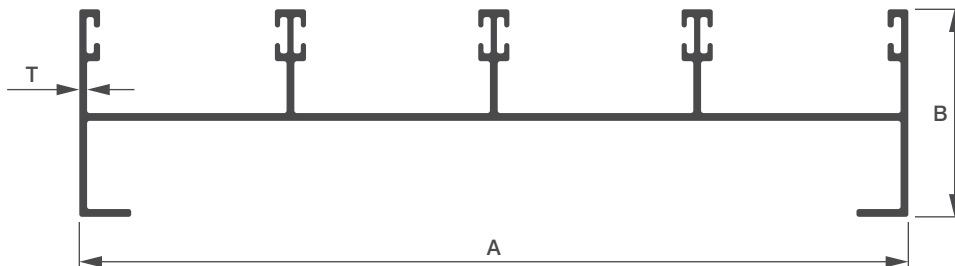

Sl. No.	Sec. No.	A	B	T	Wt. Range KG/12'
1	8803	159.80	40.00	1.50	5.450 - 5.650

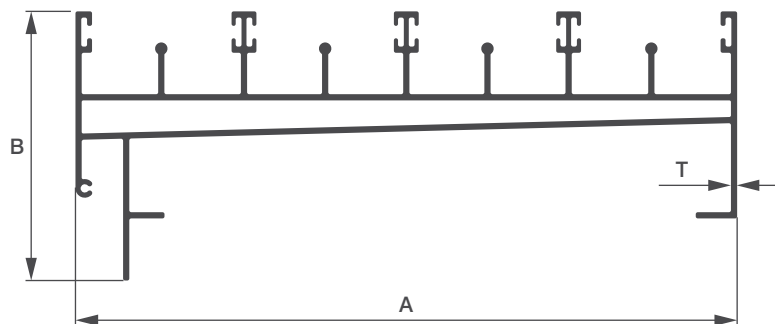

Sl. No.	Sec. No.	A	B	T	Wt. Range KG/12'
1	8806	159.80	65.00	1.50	9.400 - 9.600



SLIDING WINDOWS

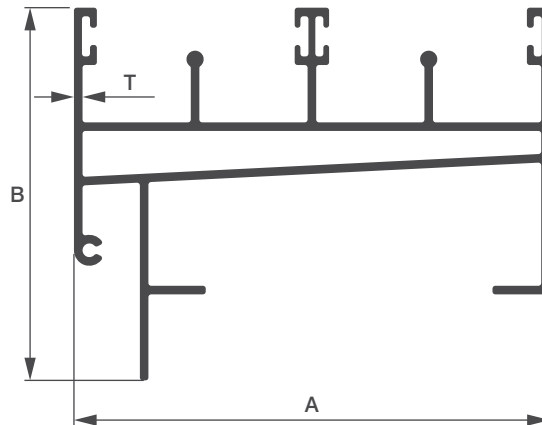

Sl. No.	Sec. No.	A	B	T	Wt. Range KG/12'
1	8804	83.00	65.00	1.50	5.800 - 6.000

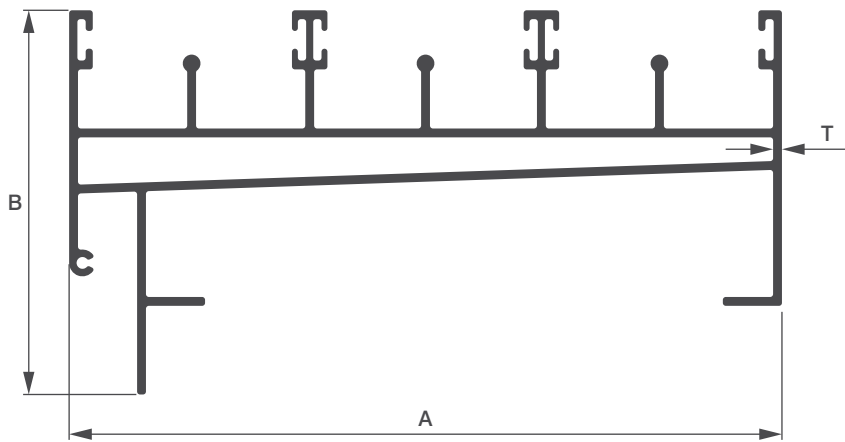

Sl. No.	Sec. No.	A	B	T	Wt. Range KG/12'
1	8805	120.60	65.00	1.50	7.575 - 7.775

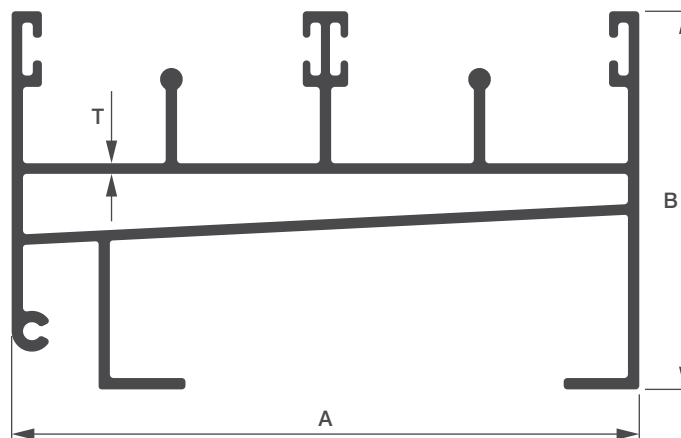

Sl. No.	Sec. No.	A	B	T	Wt. Range KG/12'
1	8810	83.00	50.00	1.40	5.425 - 6.000



SLIDING WINDOWS

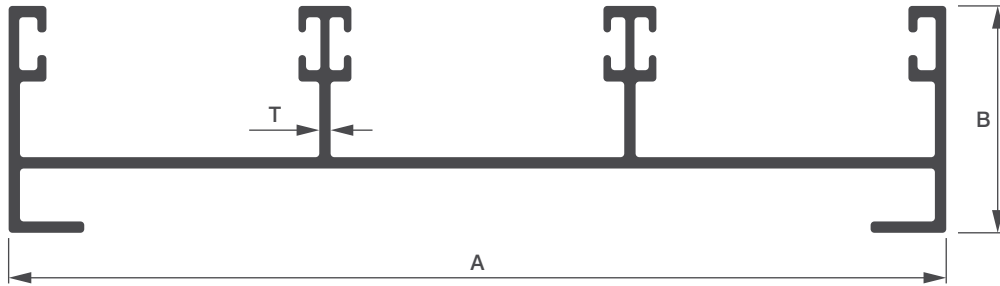

Sl. No.	Sec. No.	A	B	T	Wt. Range KG/12'
1	7926	124.00	30.00	1.50	4.250 - 4.650

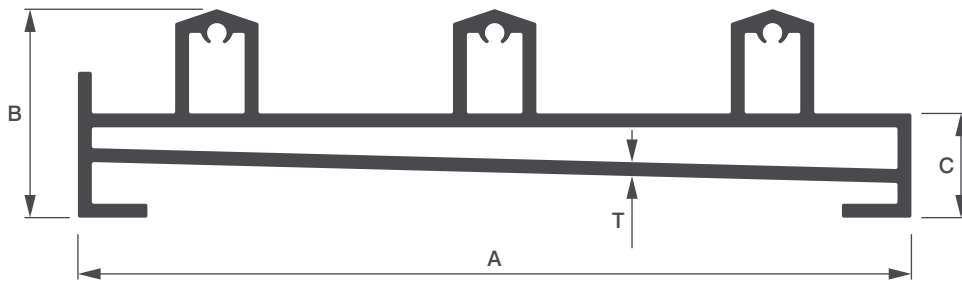

Sl. No.	Sec. No.	A	B	C	T	Wt. Range KG/12'
1	7925	120.00	30.00	15.00	2.00	7.800 - 8.300

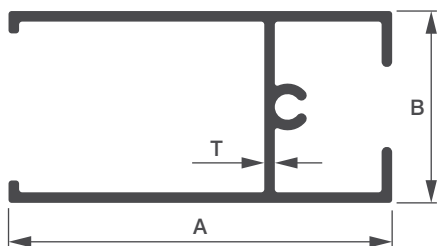

Sl. No.	Sec. No.	A	B	T	Wt. Range KG/12'
1	8808	60.00	30.00	1.65	2.825 - 3.100

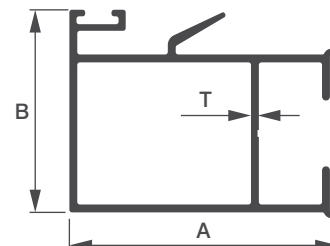

Sl. No.	Sec. No.	A	B	T	Wt. Range KG/12'
1	8809	51.00	38.50	1.50	3.000 - 3.300

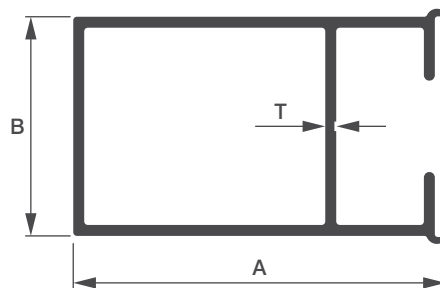

Sl. No.	Sec. No.	A	B	T	Wt. Range KG/12'
1	8807	51.00	30.00	1.50	2.500 - 2.700



SLIDING WINDOWS

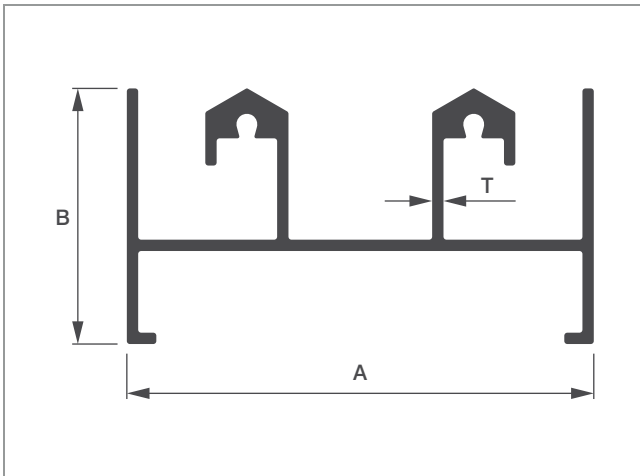

Sl. No.	Sec. No.	A	B	T	Wt. Range KG/12'
1	1865	61.75	33.80	1.50	3.400 - 3.600

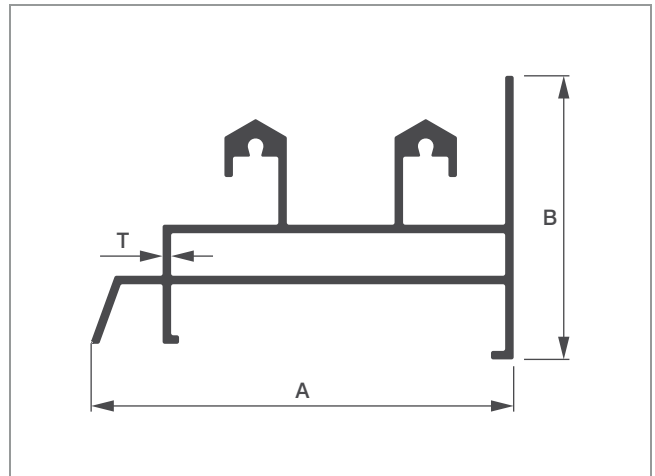

Sl. No.	Sec. No.	A	B	T	Wt. Range KG/12'
1	1866	74.50	50.00	1.50	4.200 - 4.400

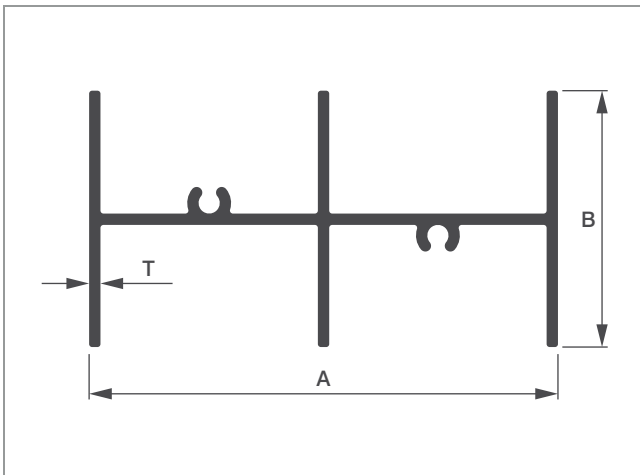

Sl. No.	Sec. No.	A	B	T	Wt. Range KG/12'
1	1867	62.00	33.90	1.50	2.500 - 2.700

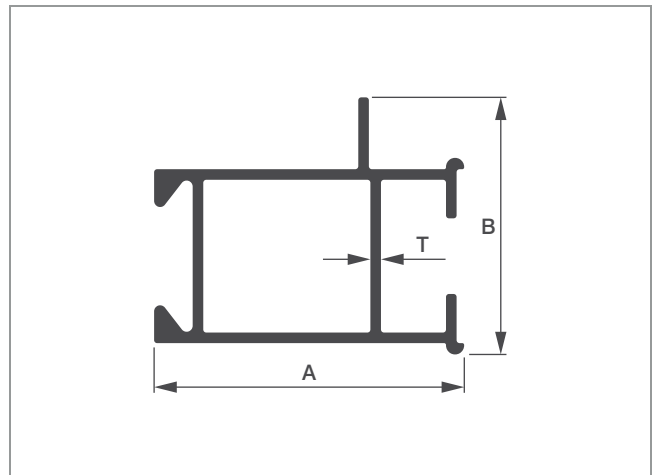

Sl. No.	Sec. No.	A	B	T	Wt. Range KG/12'
1	1868	41.00	34.00	1.40	2.180 - 2.350

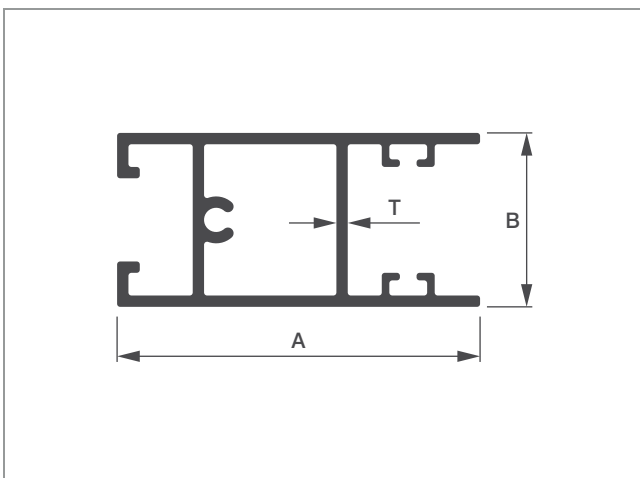

Sl. No.	Sec. No.	A	B	T	Wt. Range KG/12'
1	1869	48.00	23.00	1.50	2.500 - 2.700

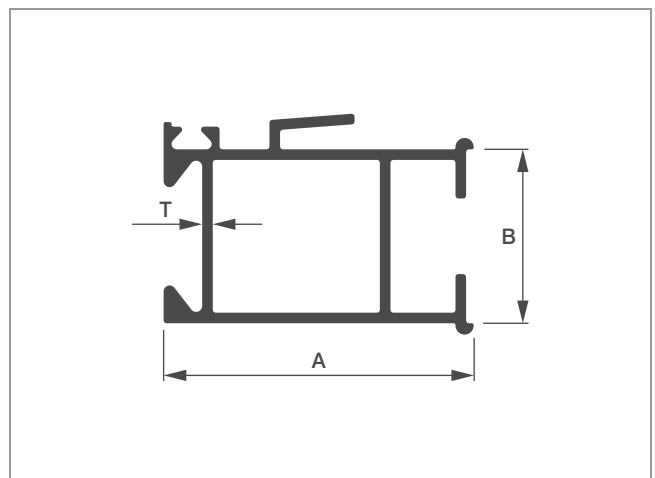

Sl. No.	Sec. No.	A	B	T	Wt. Range KG/12'
1	1870	41.00	23.00	1.40	2.185 - 2.350



SLIDING WINDOWS

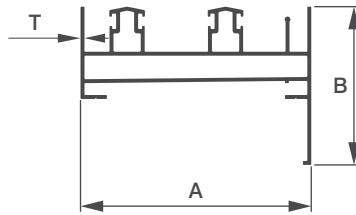

Sl. No.	Sec. No.	A	B	T	Wt. Range KG/12'
1	8831	105.00	72.00	1.80	8.400 - 8.800

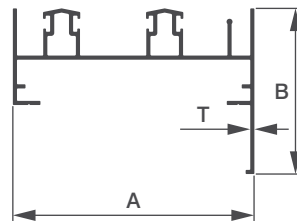

Sl. No.	Sec. No.	A	B	T	Wt. Range KG/12'
1	8832	105.00	72.00	1.80	6.700 - 7.100

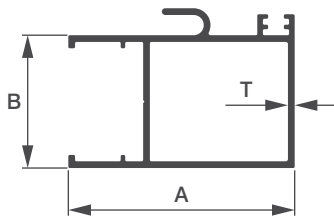

Sl. No.	Sec. No.	A	B	T	Wt. Range KG/12'
1	8833	60.50	35.50	1.80	3.900 - 4.300

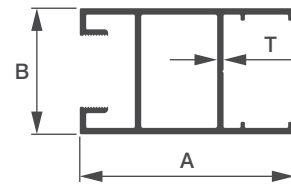

Sl. No.	Sec. No.	A	B	T	Wt. Range KG/12'
1	8835	60.50	35.50	1.80	3.800 - 4.100

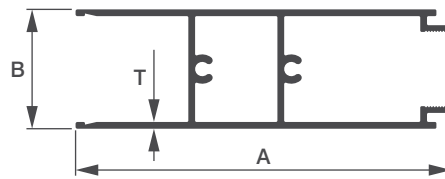

Sl. No.	Sec. No.	A	B	T	Wt. Range KG/12'
1	8853	100.00	31.75	1.80	5.100 - 5.500

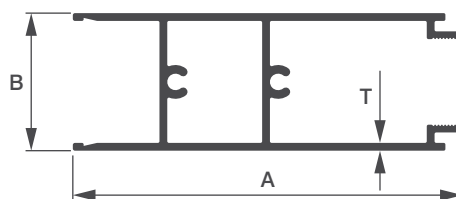

Sl. No.	Sec. No.	A	B	T	Wt. Range KG/12'
1	8834	100.00	31.75	1.80	5.000 - 5.400



SLIDING WINDOWS

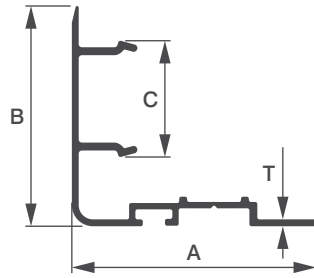

Sl. No.	Sec. No.	A	B	C	T	Wt. Range KG/12'
1	8874	46.30	41.73	22.00	1.30	1.500 - 1.950

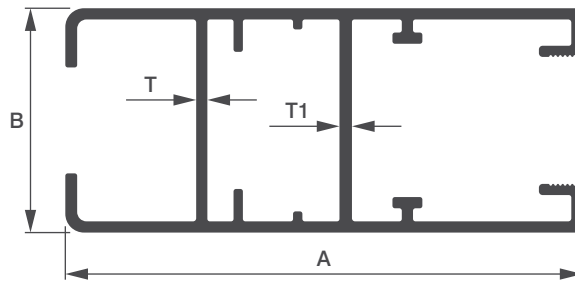

Sl. No.	Sec. No.	A	B	T	T1	Wt. Range KG/12'
1	8875	83.00	36.00	1.80	2.00	5.250 - 5.850

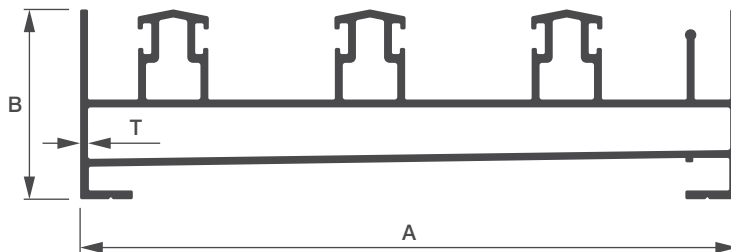

Sl. No.	Sec. No.	A	B	T	Wt. Range KG/12'
1	8872	149.80	43.20	1.80	10.700 - 11.400

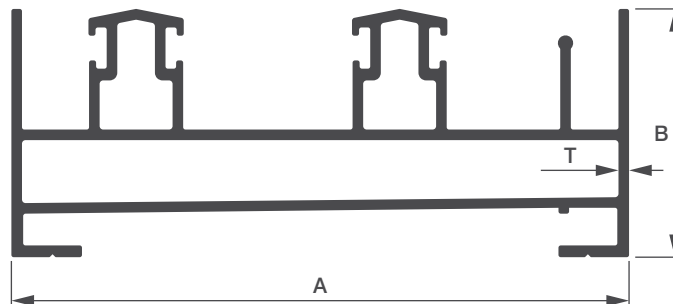

Sl. No.	Sec. No.	A	B	T	Wt. Range KG/12'
1	8873	105.00	42.20	1.80	8.000 - 8.700



SLIDING WINDOWS

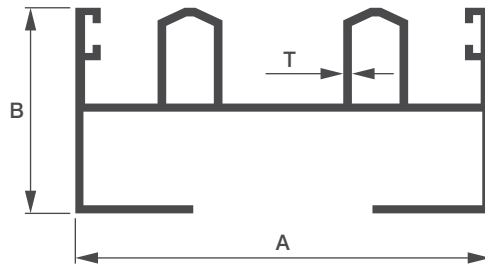

Sl. No.	Sec. No.	A	B	T	Wt. Range KG/12'
1	7351	76.72	38.00	1.60	4.400 - 4.800

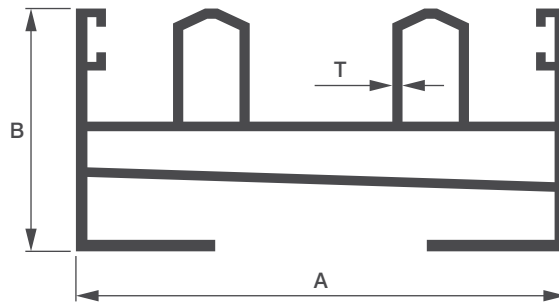

Sl. No.	Sec. No.	A	B	T	Wt. Range KG/12'
1	7352	76.72	38.00	1.60	5.700 - 6.100

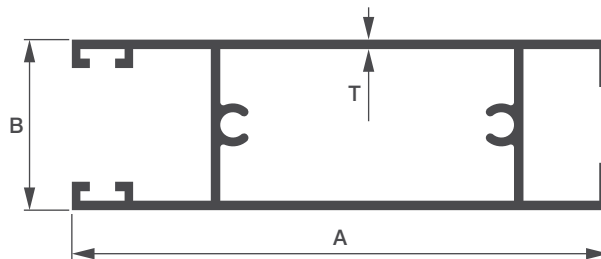

Sl. No.	Sec. No.	A	B	T	Wt. Range KG/12'
1	7353	85.00	27.00	1.50	3.850 - 4.150

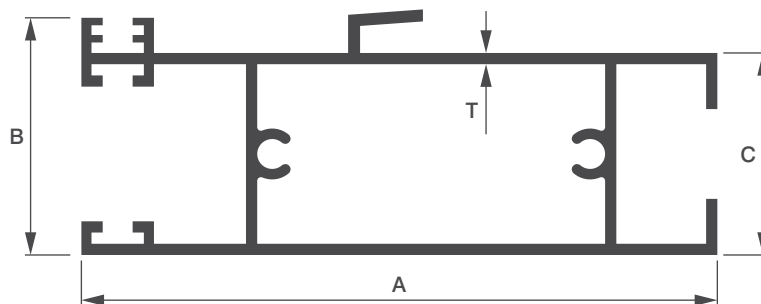

Sl. No.	Sec. No.	A	B	C	T	Wt. Range KG/12'
1	7354	85.00	31.70	27.00	1.50	4.250 - 4.650



SLIDING WINDOWS

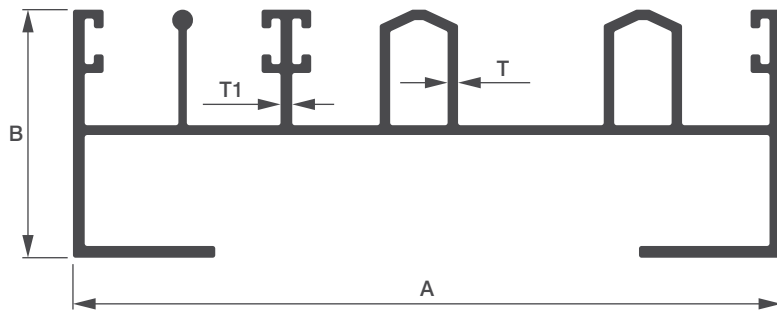

Sl. No.	Sec. No.	A	B	T	T1	Wt. Range KG/12'
1	7601	108.52	38.00	1.60	1.80	5.900 - 6.300

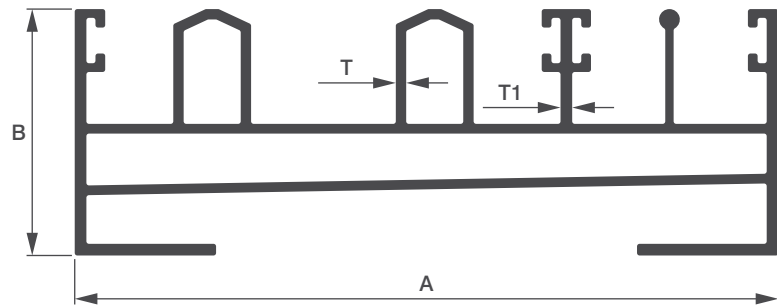

Sl. No.	Sec. No.	A	B	T	T1	Wt. Range KG/12'
1	7602	108.52	38.00	1.60	1.80	7.500 - 7.900

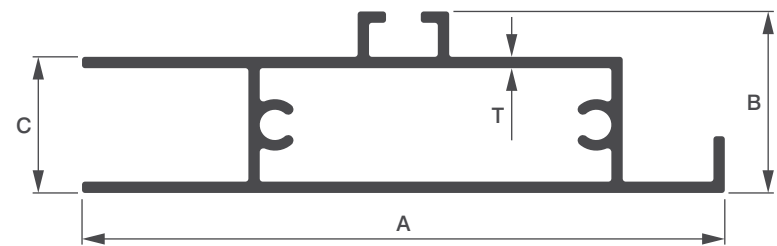

Sl. No.	Sec. No.	A	B	C	T	Wt. Range KG/12'
1	7606	85.00	24.00	18.00	1.50	3.300 - 3.600

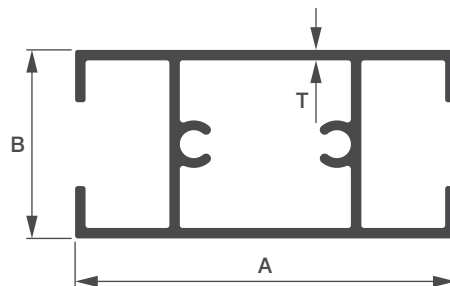

Sl. No.	Sec. No.	A	B	T	Wt. Range KG/12'
1	7604	54.50	27.00	1.50	2.900 - 3.100



SLIDING WINDOWS

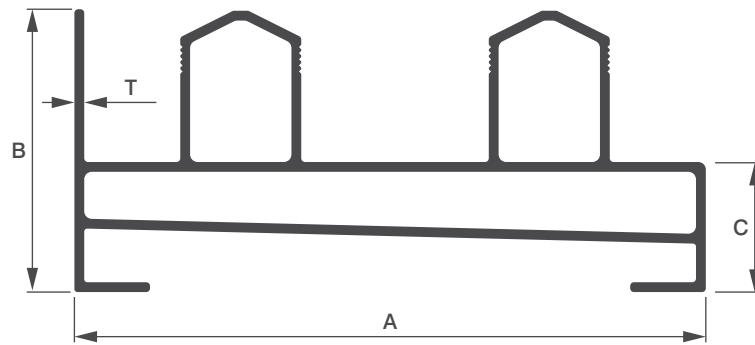

Sl. No.	Sec. No.	A	B	C	T	Wt. Range KG/12'
1	8894	83.50	37.40	17.10	1.30	4.200 - 4.700

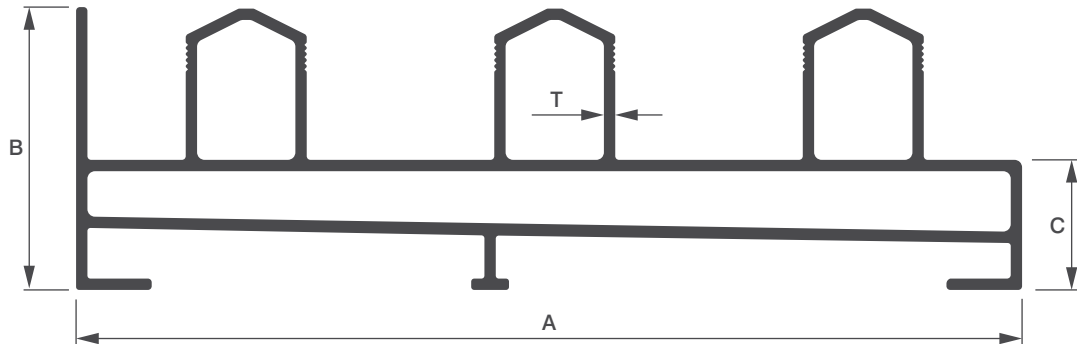

Sl. No.	Sec. No.	A	B	C	T	Wt. Range KG/12'
1	8893	125.10	37.40	17.20	1.50	7.000 - 7.600

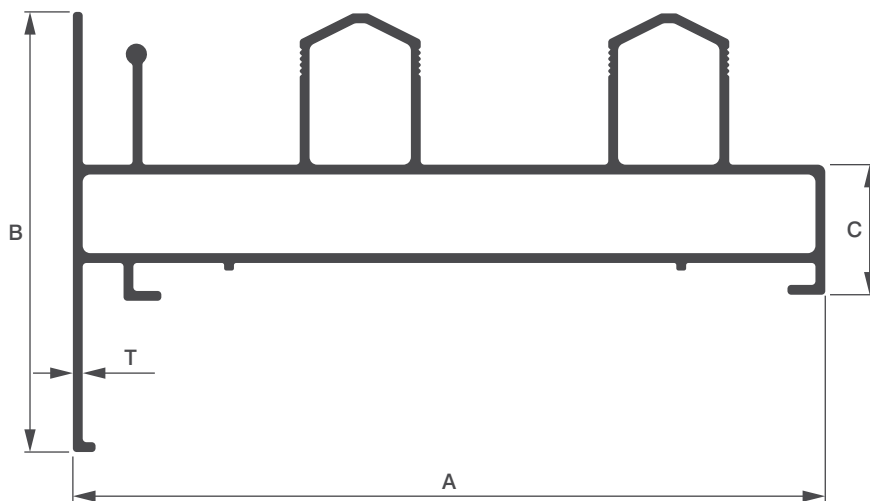

Sl. No.	Sec. No.	A	B	C	T	Wt. Range KG/12'
1	5315	99.50	58.20	17.20	1.30	5.200 - 5.600



SLIDING WINDOWS

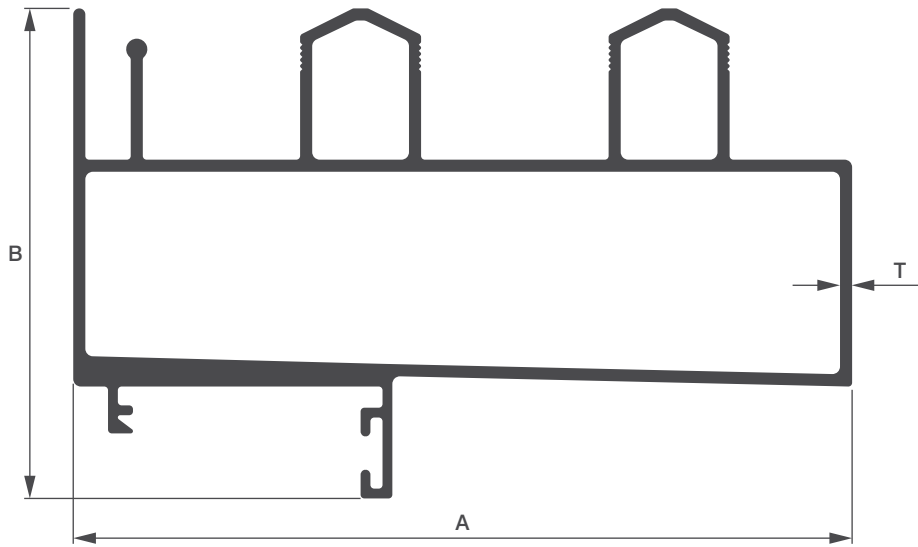

Sl. No.	Sec. No.	A	B	T	Wt. Range KG/12'
1	5344	103.00	64.80	1.60	11.600 - 12.200

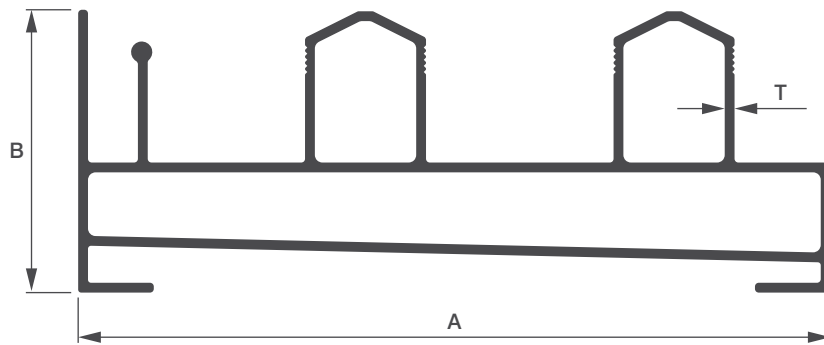

Sl. No.	Sec. No.	A	B	T	Wt. Range KG/12'
1	8864	99.50	37.40	1.30	4.800 - 5.200

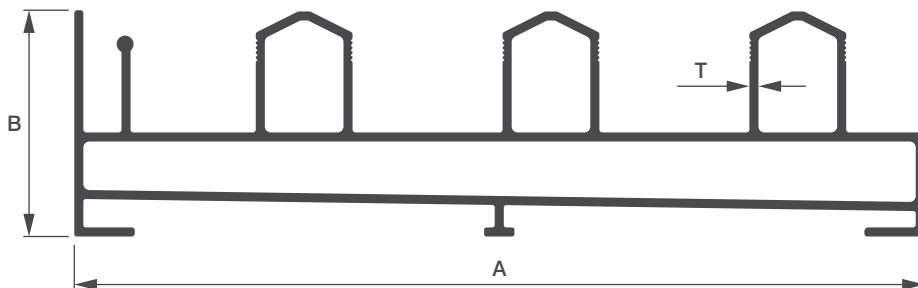

Sl. No.	Sec. No.	A	B	T	Wt. Range KG/12'
1	8865	140.60	37.40	1.50	7.600 - 8.000



SLIDING WINDOWS

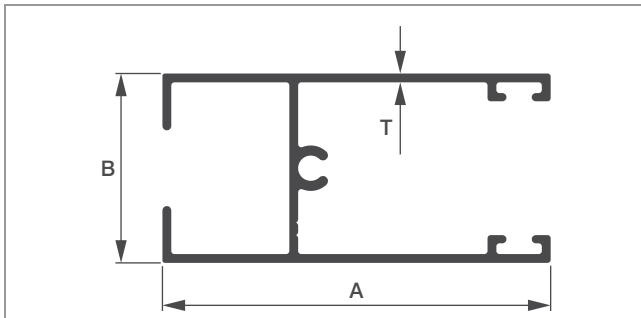

Sl. No.	Sec. No.	A	B	T	Wt. Range KG/12'
1	5311	61.50	30.00	1.40	2.800 - 3.100

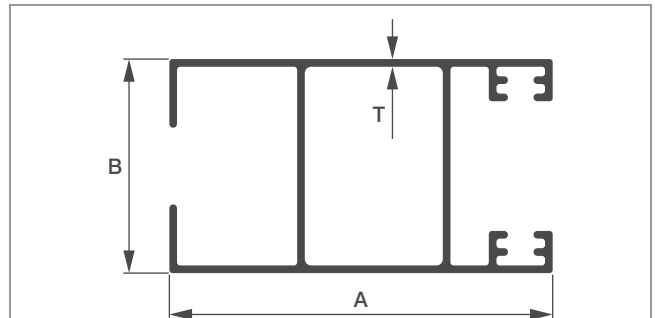

Sl. No.	Sec. No.	A	B	T	Wt. Range KG/12'
1	5313	60.00	33.50	1.20	2.800 - 3.100

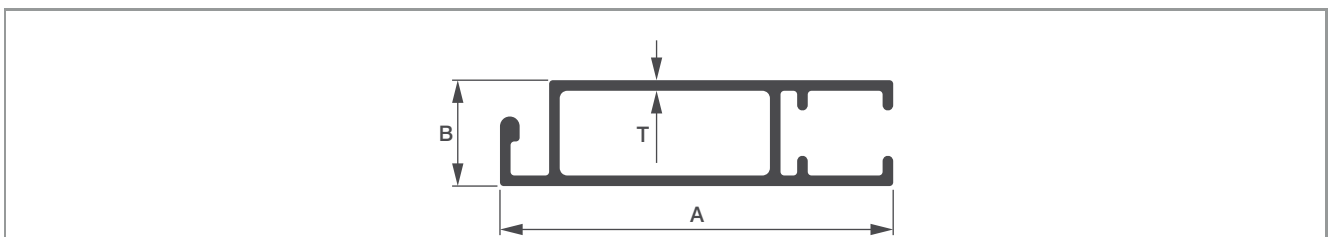

Sl. No.	Sec. No.	A	B	T	Wt. Range KG/12'
1	5310	52.00	14.00	1.40	1.900 - 2.100

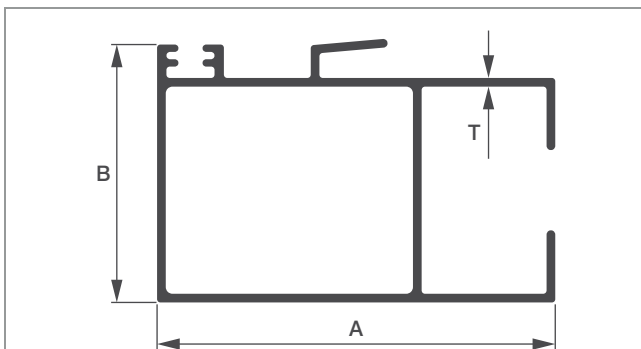

Sl. No.	Sec. No.	A	B	T	Wt. Range KG/12'
1	5312	59.60	38.60	1.30	2.900 - 3.200

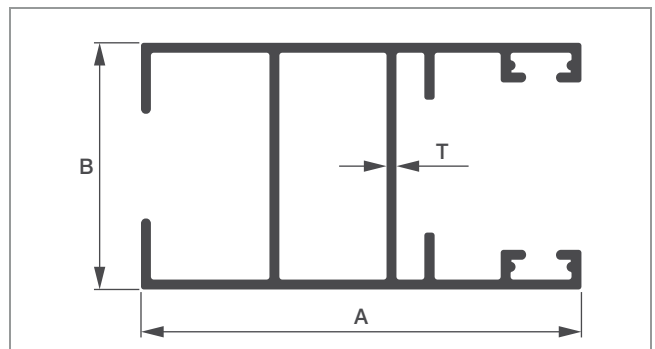

Sl. No.	Sec. No.	A	B	T	Wt. Range KG/12'
1	5347	60.00	33.60	1.35	3.000 - 3.300

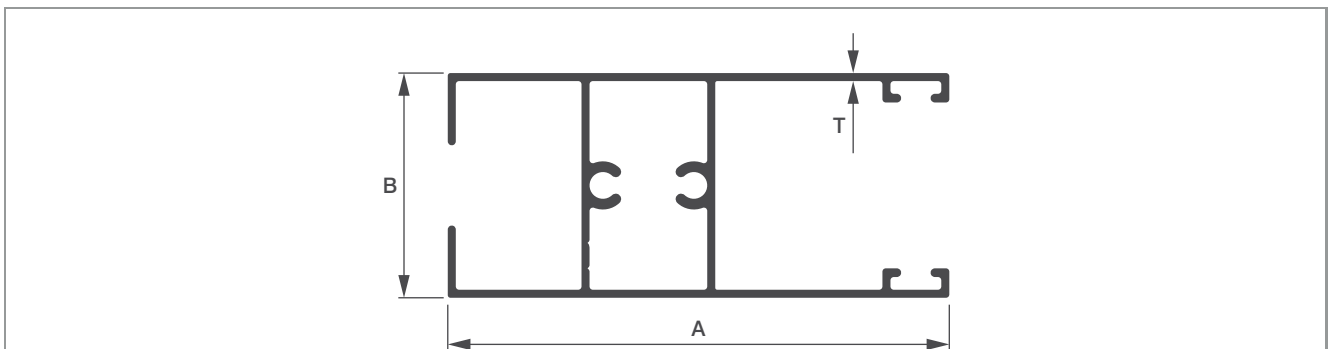

Sl. No.	Sec. No.	A	B	T	Wt. Range KG/12'
1	8895	75.00	30.00	1.40	3.600 - 3.900



SLIDING WINDOWS

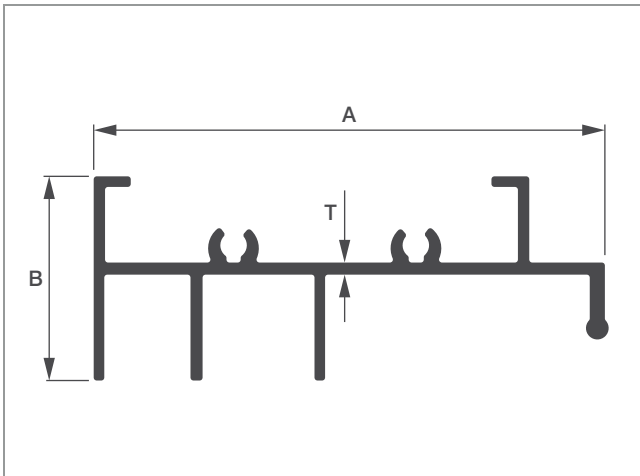

Sl. No.	Sec. No.	A	B	T	Wt. Range KG/12'
1	8876	67.60	27.00	1.60	2.550 - 2.950

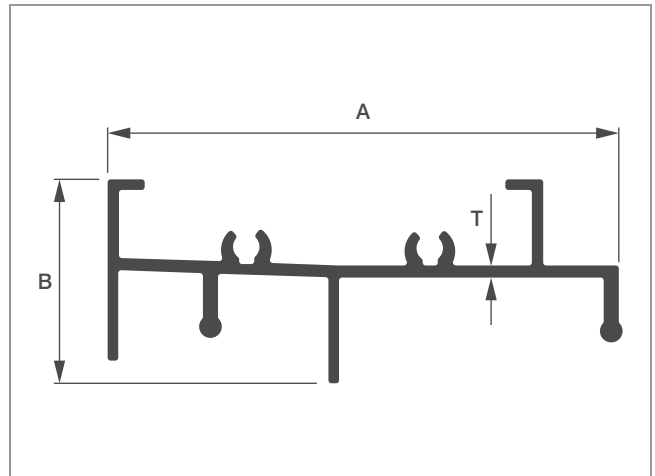

Sl. No.	Sec. No.	A	B	T	Wt. Range KG/12'
1	8877	67.60	27.00	1.60	2.450 - 2.950

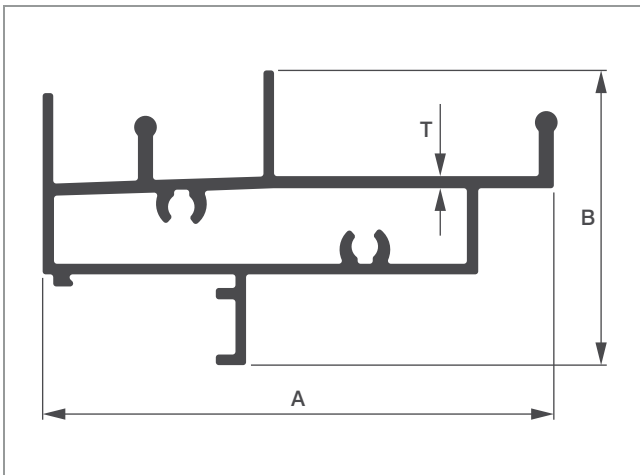

Sl. No.	Sec. No.	A	B	T	Wt. Range KG/12'
1	8878	67.60	39.00	1.60	3.400 - 3.950

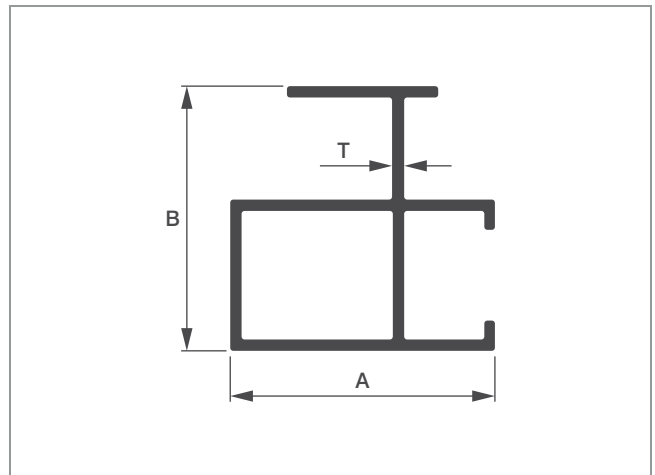

Sl. No.	Sec. No.	A	B	T	Wt. Range KG/12'
1	8879	35.00	35.00	1.60	2.100 - 2.600

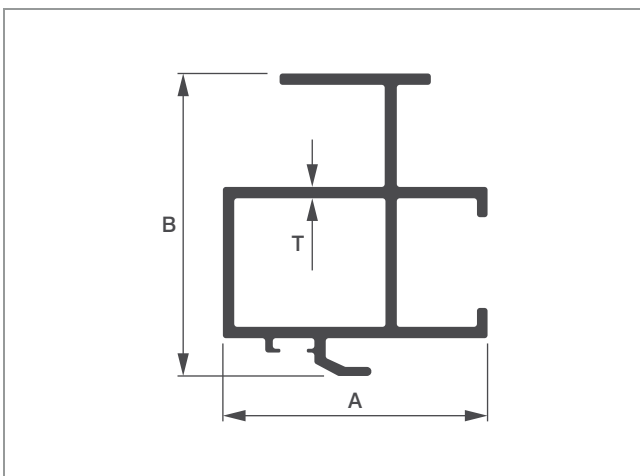

Sl. No.	Sec. No.	A	B	T	Wt. Range KG/12'
1	8880	35.00	40.00	1.50	2.250 - 2.750

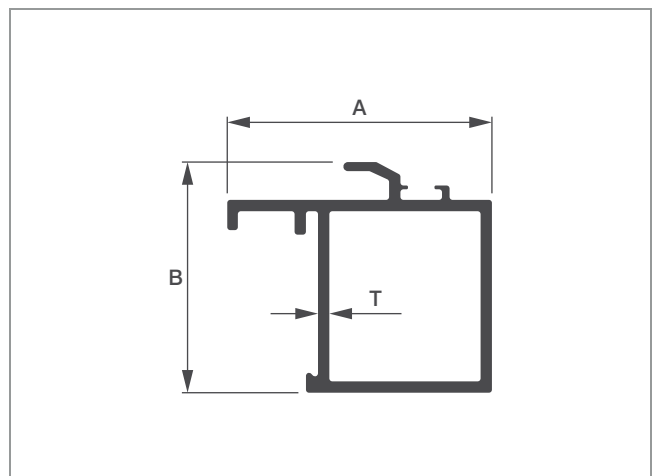

Sl. No.	Sec. No.	A	B	T	Wt. Range KG/12'
1	8881	35.00	30.50	1.50	1.800 - 2.300



SLIDING WINDOWS

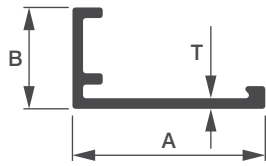

Sl. No.	Sec. No.	A	B	T	Wt. Range KG/12'
1	8882	25.50	13.40	1.40	0.650 - 1.050

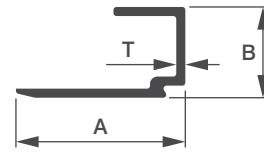

Sl. No.	Sec. No.	A	B	T	Wt. Range KG/12'
1	8883	22.40	12.00	1.20	0.450 - 0.950

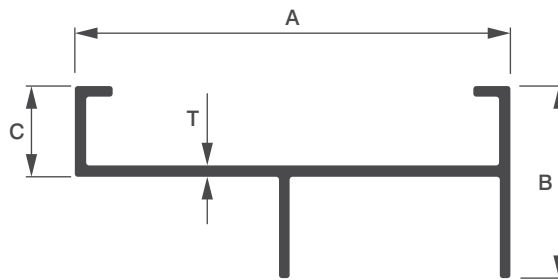

Sl. No.	Sec. No.	A	B	C	T	Wt. Range KG/12'
1	8884	57.60	25.40	12.00	1.50	1.600 - 2.100

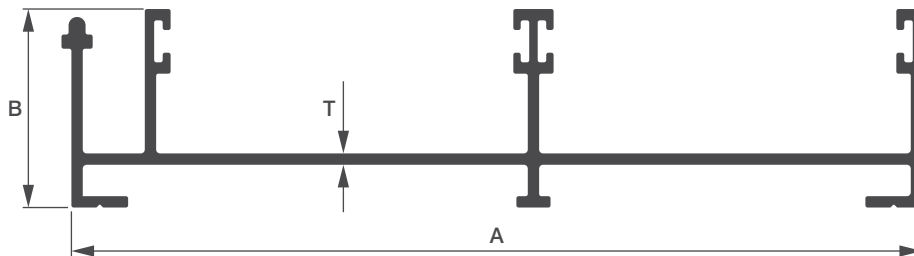

Sl. No.	Sec. No.	A	B	T	Wt. Range KG/12'
1	7829	150.00	35.00	2.00	6.300 - 7.200

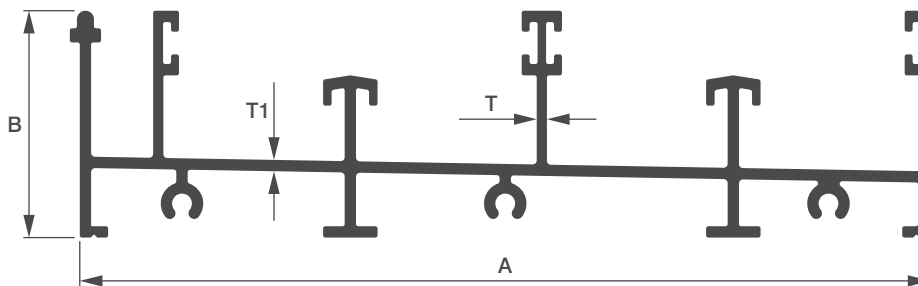

Sl. No.	Sec. No.	A	B	T	T1	Wt. Range KG/12'
1	7830	150.00	40.00	1.80	2.00	8.900 - 9.500



SLIDING WINDOWS

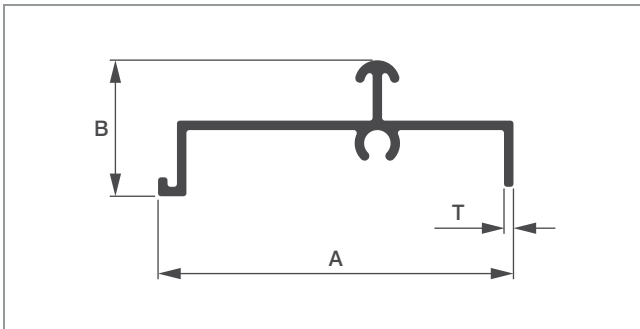

Sl. No.	Sec. No.	A	B	T	Wt. Range KG/12'
1	8838	47.00	18.00	1.25	1.050 - 1.300

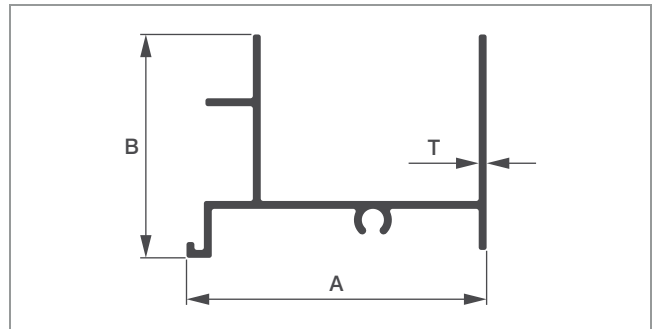

Sl. No.	Sec. No.	A	B	T	Wt. Range KG/12'
1	8840	47.50	35.35	1.25	1.600 - 1.800

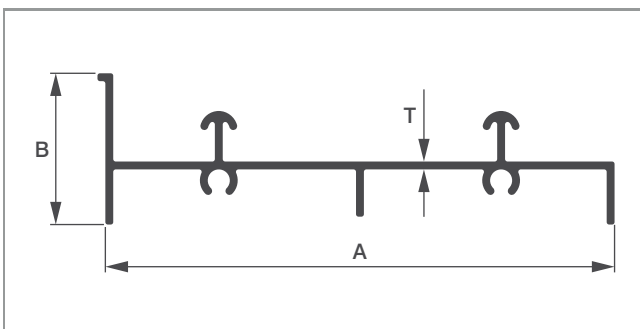

Sl. No.	Sec. No.	A	B	T	Wt. Range KG/12'
1	8839	80.80	24.00	1.25	2.000 - 2.200

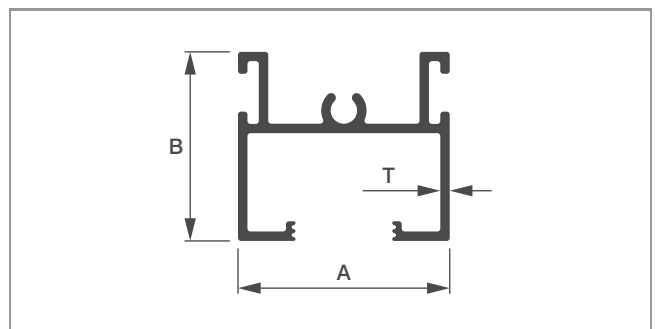

Sl. No.	Sec. No.	A	B	T	Wt. Range KG/12'
1	8841	28.00	25.00	1.25	1.300 - 1.500

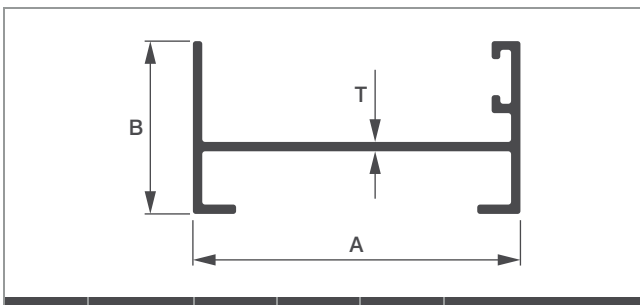

Sl. No.	Sec. No.	A	B	T	Wt. Range KG/12'
1	8842	45.50	24.00	1.30	1.350 - 1.500

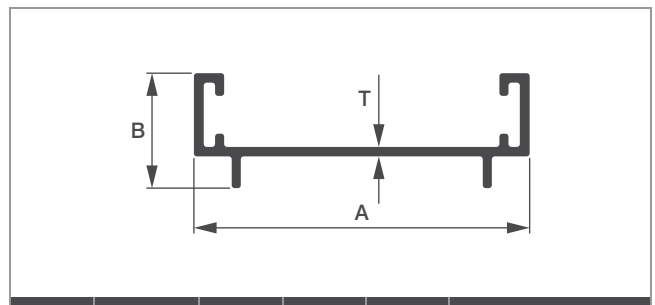

Sl. No.	Sec. No.	A	B	T	Wt. Range KG/12'
1	8843	44.40	15.20	1.25	1.000 - 1.100

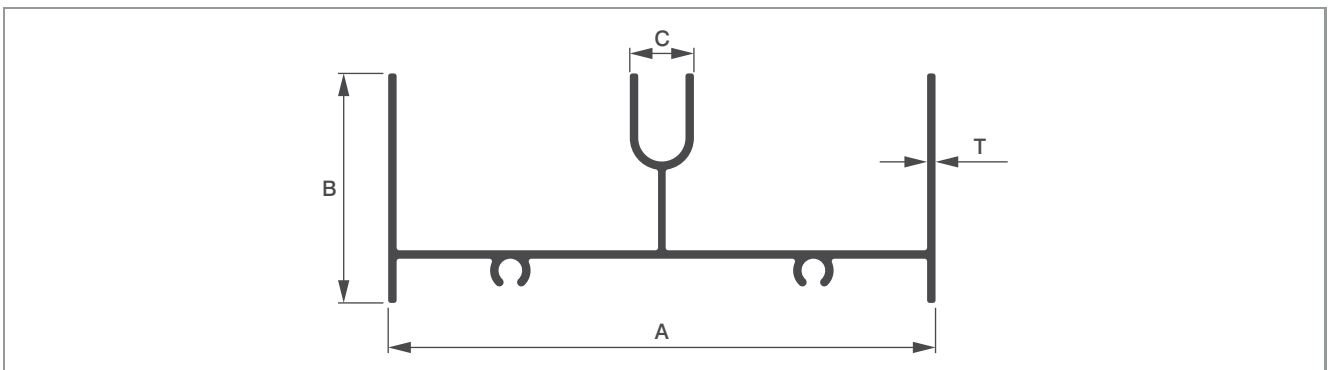

Sl. No.	Sec. No.	A	B	C	T	Wt. Range KG/12'
1	8845	81.10	34.00	9.50	1.25	2.500 - 2.700



SLIDING WINDOWS

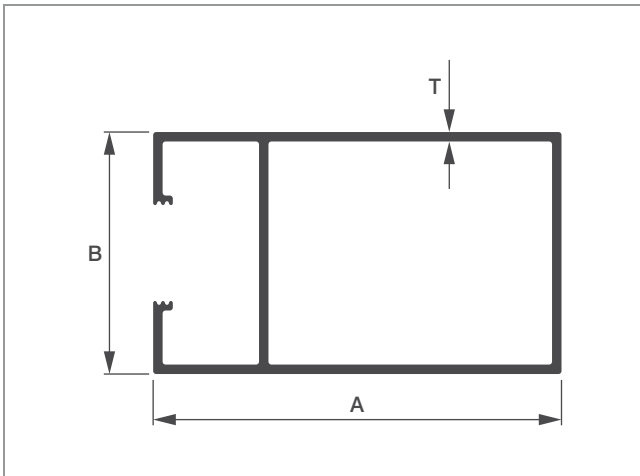

Sl. No.	Sec. No.	A	B	T	Wt. Range KG/12'
1	8846	54.00	32.00	1.25	2.250 - 2.450

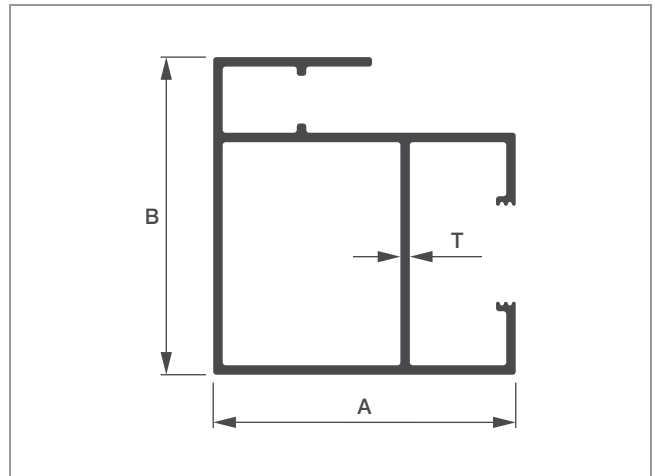

Sl. No.	Sec. No.	A	B	T	Wt. Range KG/12'
1	8847	40.00	42.00	1.25	2.300 - 2.500

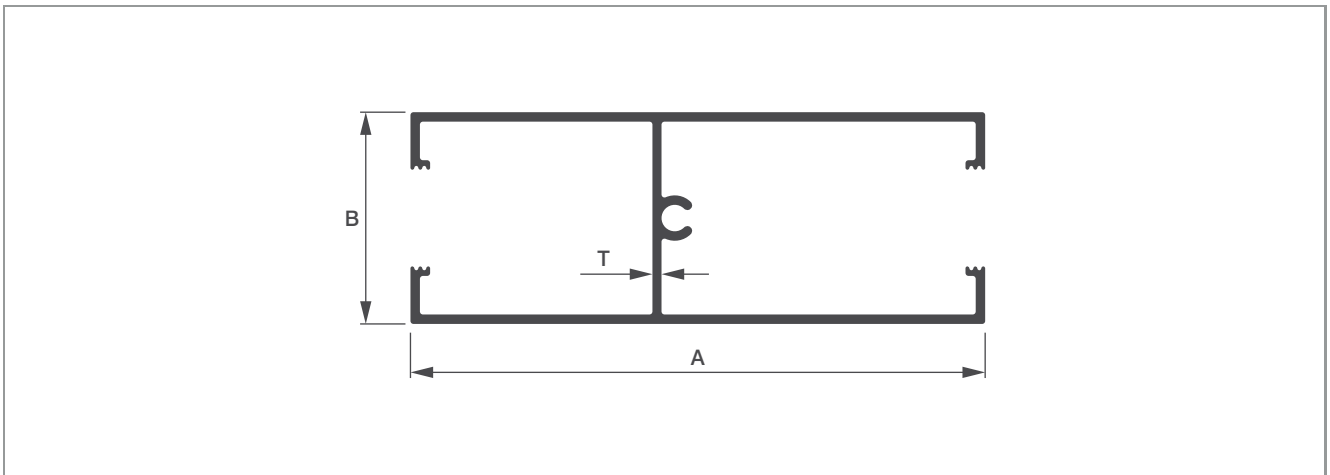

Sl. No.	Sec. No.	A	B	T	Wt. Range KG/12'
1	8848	76.00	28.00	1.20	2.600 - 2.800

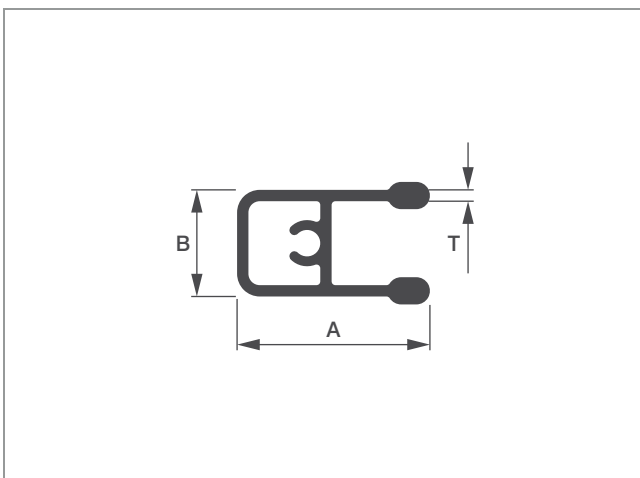

Sl. No.	Sec. No.	A	B	T	Wt. Range KG/12'
1	4508	25.50	14.10	1.50	1.350 - 1.500

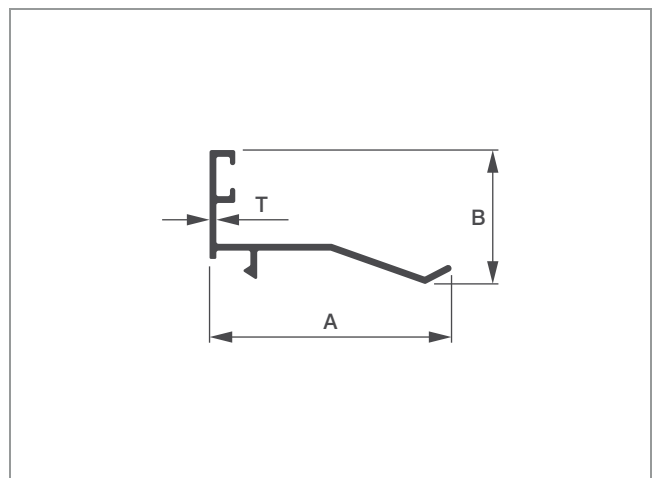

Sl. No.	Sec. No.	A	B	T	Wt. Range KG/12'
1	4510	32.00	17.70	1.20	0.500 - 0.700



SLIDING WINDOWS

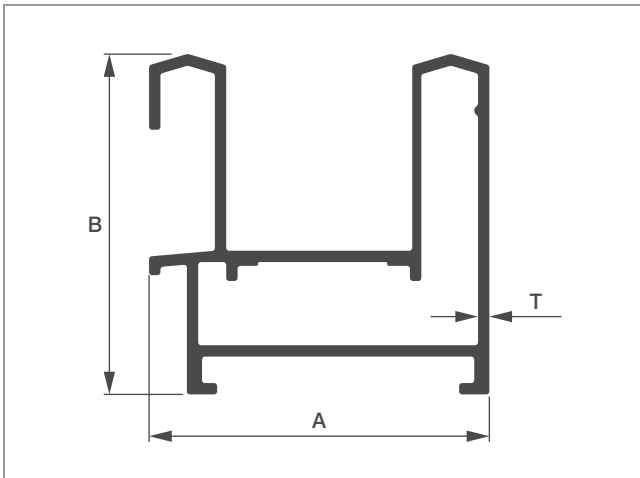

Sl. No.	Sec. No.	A	B	T	Wt. Range KG/12'
1	4509	45.00	45.00	1.50	3.200 - 3.550

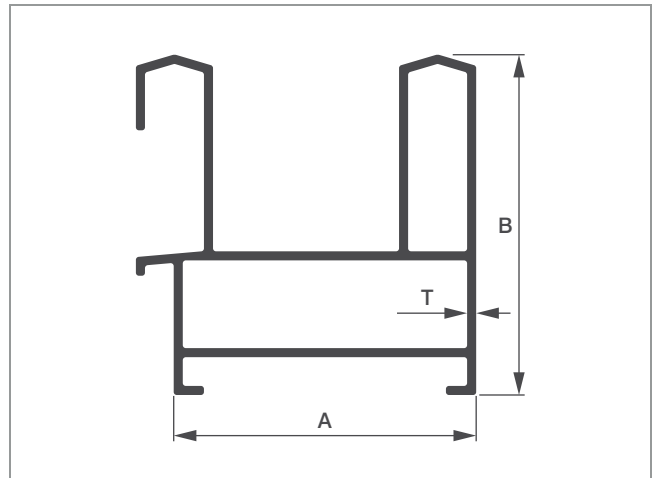

Sl. No.	Sec. No.	A	B	T	Wt. Range KG/12'
1	7481	40.00	45.00	1.20	2.650 - 3.250

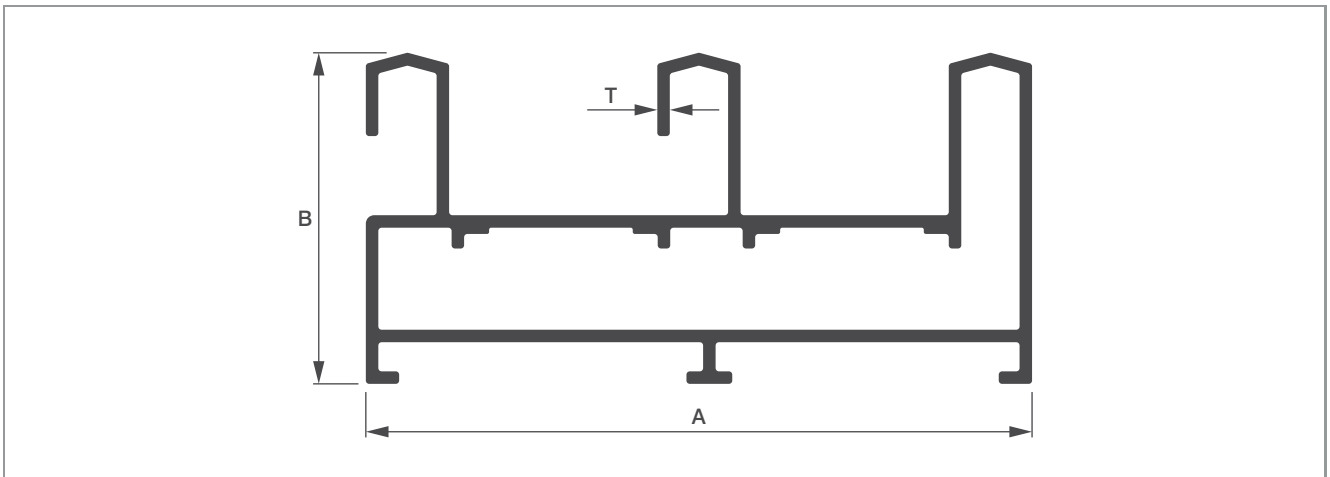

Sl. No.	Sec. No.	A	B	T	Wt. Range KG/12'
1	4558	80.00	39.75	1.50	4.900 - 5.400

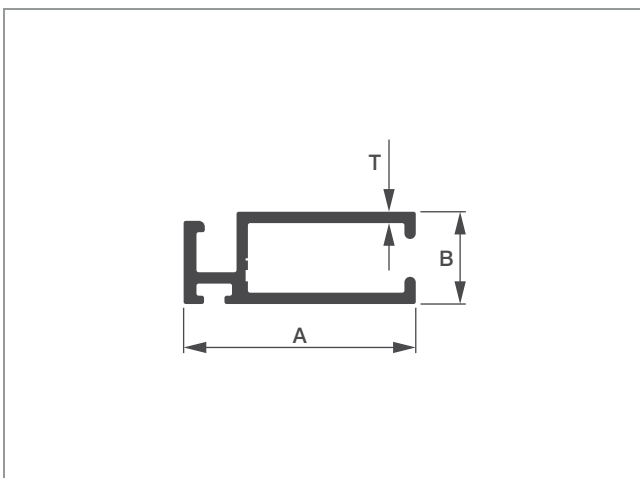

Sl. No.	Sec. No.	A	B	T	Wt. Range KG/12'
1	5484	30.70	12.20	1.50	1.200 - 1.700

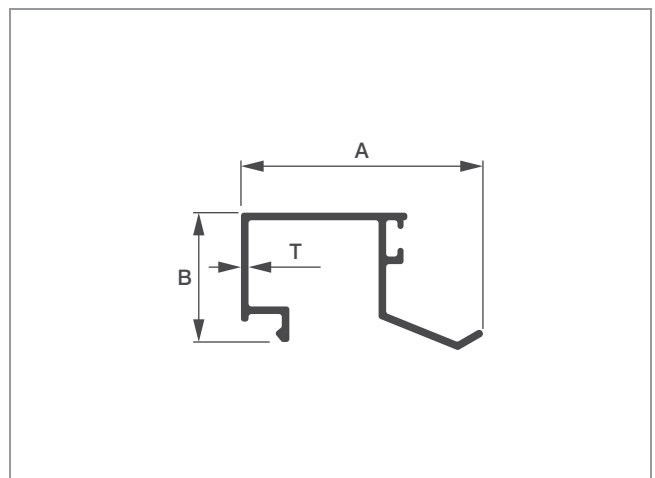

Sl. No.	Sec. No.	A	B	T	Wt. Range KG/12'
1	4516	32.00	17.10	1.00	0.750 - 1.000



SLIDING WINDOWS

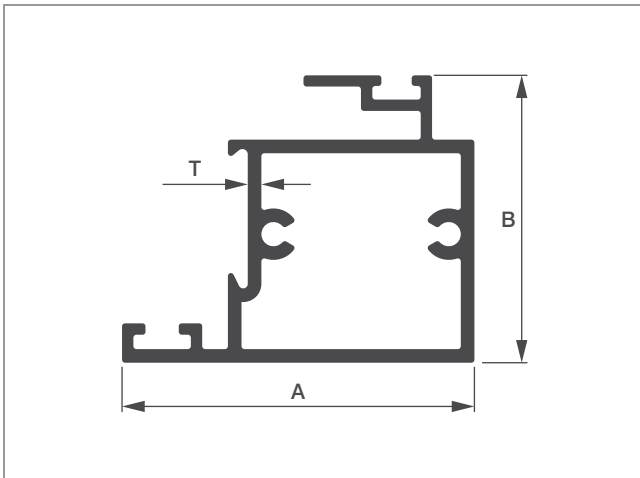

Sl. No.	Sec. No.	A	B	T	Wt. Range KG/12'
1	8857	46.60	38.00	1.80	3.200 - 3.500

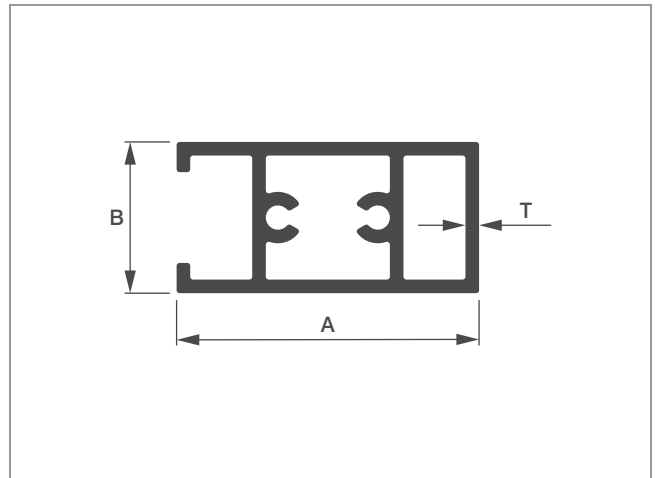

Sl. No.	Sec. No.	A	B	T	Wt. Range KG/12'
1	8858	40.00	20.00	1.80	2.650 - 2.850

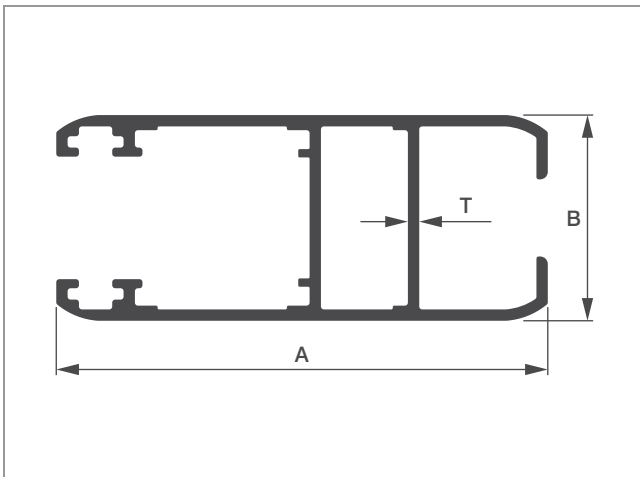

Sl. No.	Sec. No.	A	B	T	Wt. Range KG/12'
1	4504	65.00	27.20	1.50	3.250 - 3.450

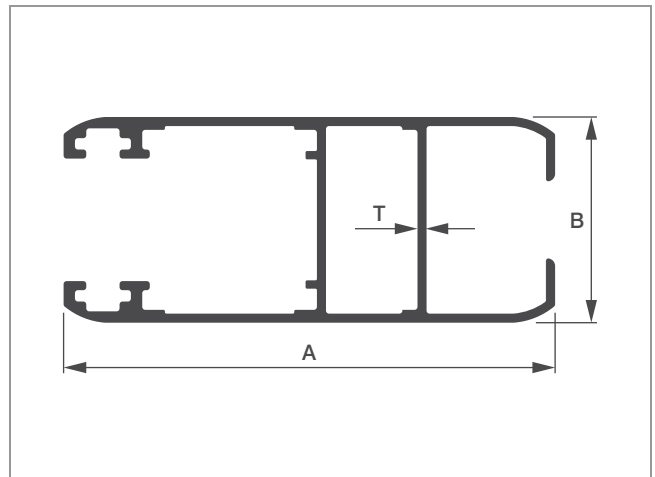

Sl. No.	Sec. No.	A	B	T	Wt. Range KG/12'
1	7480	65.00	27.20	1.20	2.750 - 3.250

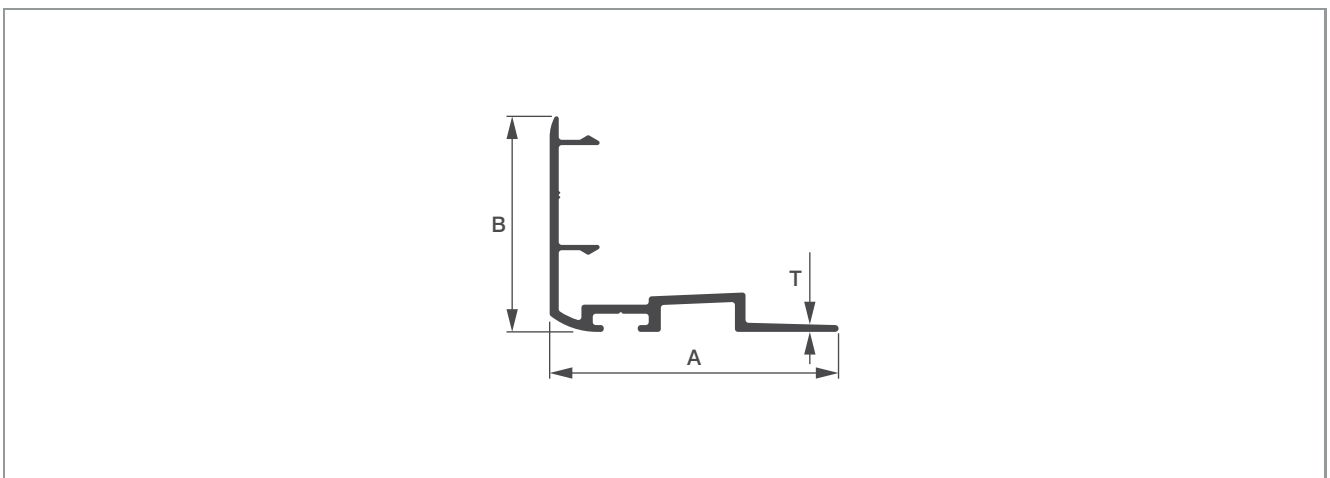

Sl. No.	Sec. No.	A	B	T	Wt. Range KG/12'
1	4514	38.20	28.50	1.20	1.000 - 1.200