

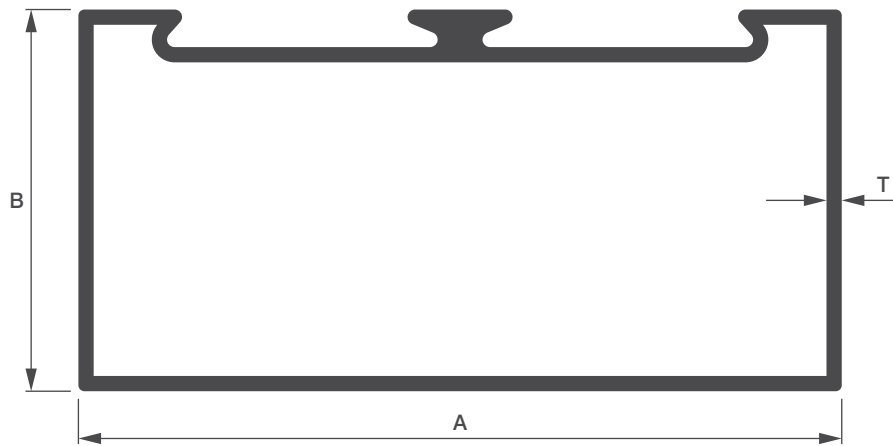

PARTITION & DOORS



Sl. No.	Sec. No.	A	B	T	Wt. Range KG/12'
1	1601/L	48.00	24.00	0.75	1.100 - 1.300
2	1601	48.00	24.00	0.85	1.400 - 1.600
3	1603	50.00	37.00	0.75	1.400 - 1.600
4	1617	50.30	25.00	0.70	1.200 - 1.400
5	1641	50.80	25.40	1.25	2.000 - 2.300
6	1605/L	63.00	38.00	0.80	1.600 - 1.800
7	1605	63.00	38.00	0.90	1.800 - 2.000
8	1607	63.00	38.00	1.00	2.000 - 2.300
9	1607/H	63.00	38.00	1.15	2.300 - 2.650
10	1609	63.00	38.00	1.35	2.700 - 3.100
11	1609/H	63.00	38.00	1.50	3.200 - 3.500
12	1611	63.00	38.00	1.75	3.700 - 4.200
13	1613	63.00	38.00	2.50	5.000 - 5.500
14	1615	63.00	38.00	3.00	5.900 - 6.400
15	1643	92.00	25.00	0.97	2.200 - 2.600
16	1619	101.20	44.45	1.40	3.600 - 4.100
17	1621	101.20	44.45	1.90	5.800 - 6.300
18	1625	101.20	44.45	2.40	7.000 - 7.500
19	1623	101.20	44.45	2.80	8.000 - 8.400
20	1623/H	101.20	44.45	3.00	8.800 - 9.300
21	1645	116.00	25.00	0.95	2.600 - 3.000



PARTITION & DOORS

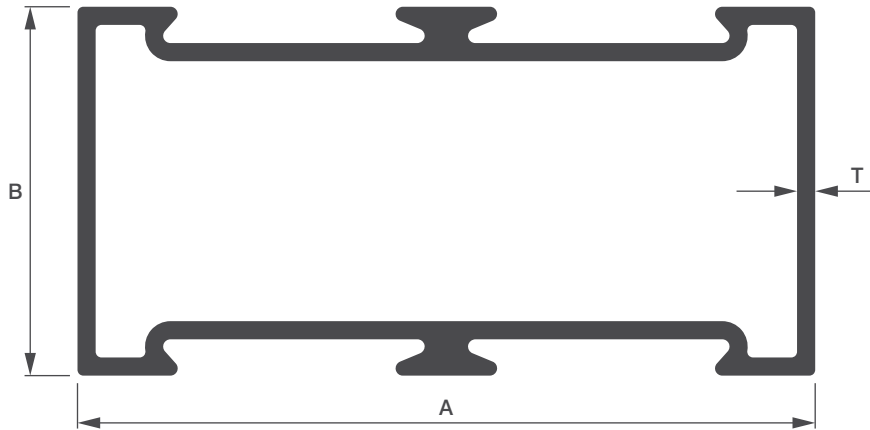

Sl. No.	Sec. No.	A	B	T	Wt. Range KG/12'
1	1602/L	48.00	24.00	0.72	1.100 - 1.300
2	1602	48.00	24.00	0.80	1.400 - 1.600
3	1604	50.00	37.00	0.80	1.500 - 1.700
4	1618	50.30	25.00	0.70	1.300 - 1.500
5	1642	50.80	25.40	1.35	2.000 - 2.350
6	1606/L	63.00	38.00	0.75	1.600 - 1.800
7	1606	63.00	38.00	0.85	1.800 - 2.000
8	1608	63.00	38.00	0.95	2.000 - 2.300
9	1608/H	63.00	38.00	1.10	2.300 - 2.650
10	1610	63.00	38.00	1.30	2.700 - 3.100
11	1610/H	63.00	38.00	1.45	3.200 - 3.500
12	1612	63.00	38.00	1.70	3.700 - 4.200
13	1614	63.00	38.00	2.45	5.000 - 5.500
14	1616	63.00	38.00	2.90	5.900 - 6.400
15	1620	101.20	44.45	1.35	3.700 - 4.200
16	1622	101.20	44.45	1.85	5.800 - 6.300
17	1626	101.20	44.45	2.35	7.000 - 7.500
18	1624	101.20	44.45	2.75	8.000 - 8.400
19	1624/H	101.20	44.45	3.00	8.800 - 9.300



PARTITION & DOORS

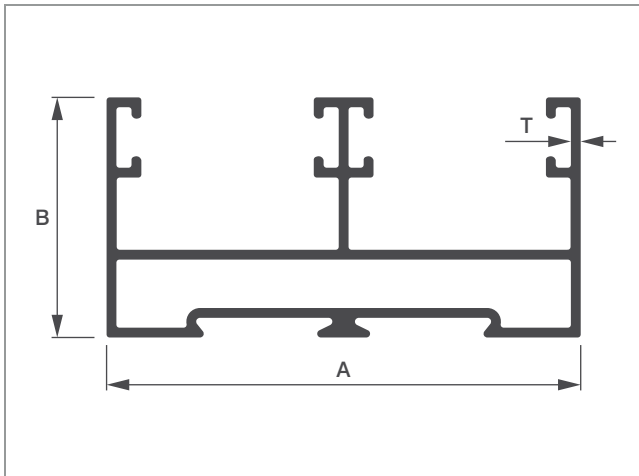

Sl. No.	Sec. No.	A	B	T	Wt. Range KG/12'
1	1630	62.70	31.75	1.35	3.700 - 4.100

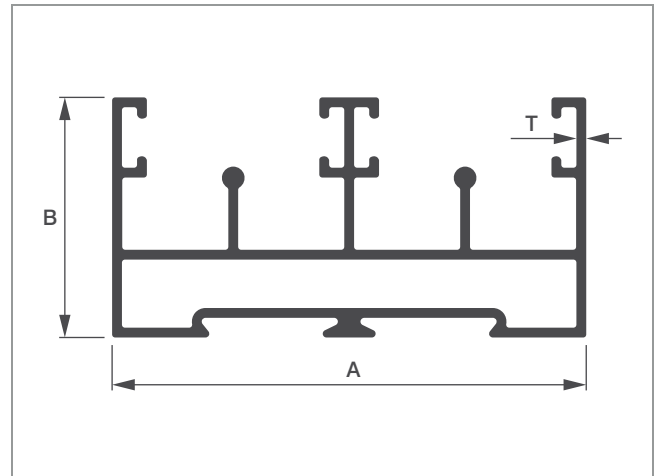

Sl. No.	Sec. No.	A	B	T	Wt. Range KG/12'
1	1631	62.70	31.75	1.45	4.050 - 4.400

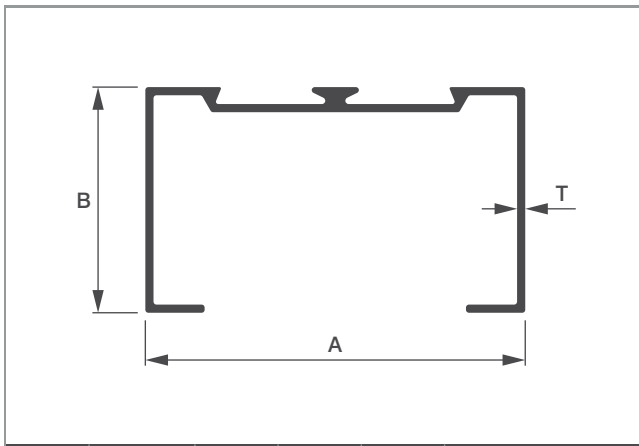

Sl. No.	Sec. No.	A	B	T	Wt. Range KG/12'
1	1632	62.80	37.30	1.30	2.300 - 2.600
2	1635	101.20	44.45	3.00	6.500 - 6.800

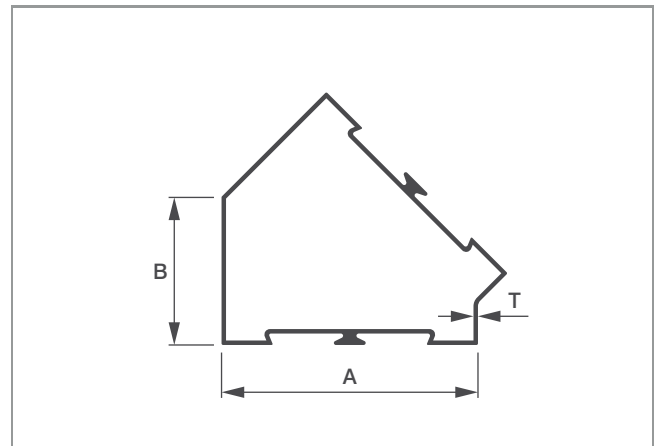

Sl. No.	Sec. No.	A	B	T	Wt. Range KG/12'
1	1633	62.80	35.73	1.15	3.200 - 3.600

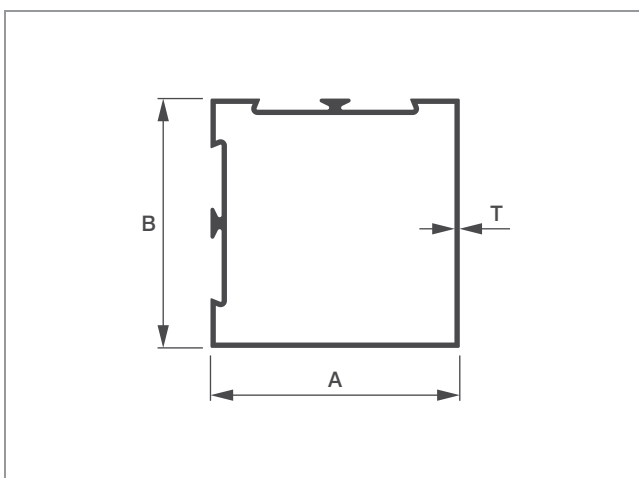

Sl. No.	Sec. No.	A	B	T	Wt. Range KG/12'
1	1634	62.80	62.80	1.30	3.500 - 3.900

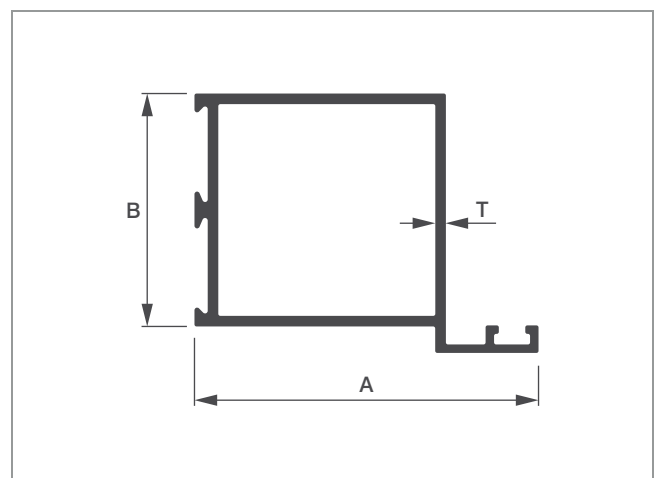

Sl. No.	Sec. No.	A	B	T	Wt. Range KG/12'
1	1636	65.00	44.00	2.00	4.140 - 4.575



PARTITION & DOORS

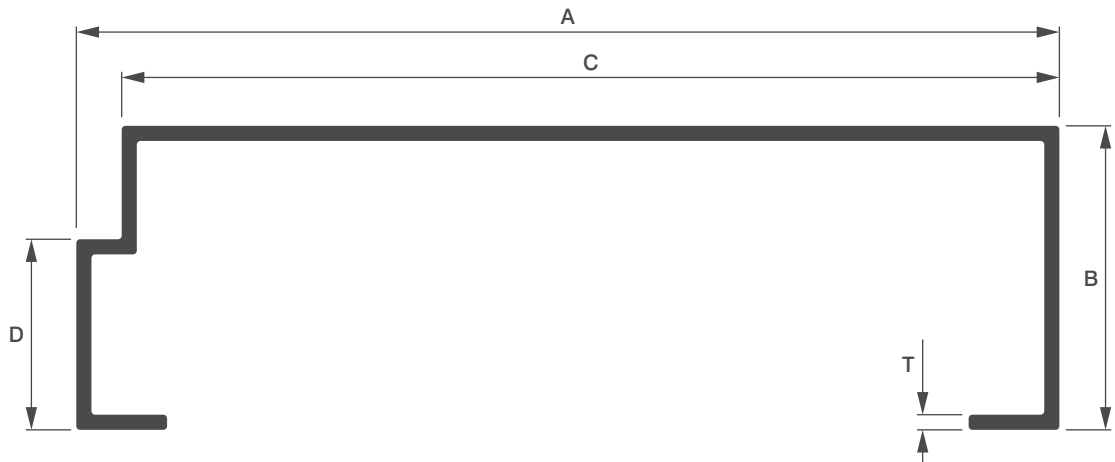

Sl. No.	Sec. No.	A	B	C	D	T	Wt. Range KG/12'
1	1646	130.00	40.20	124.00	25.20	2.00	4.500 - 5.000

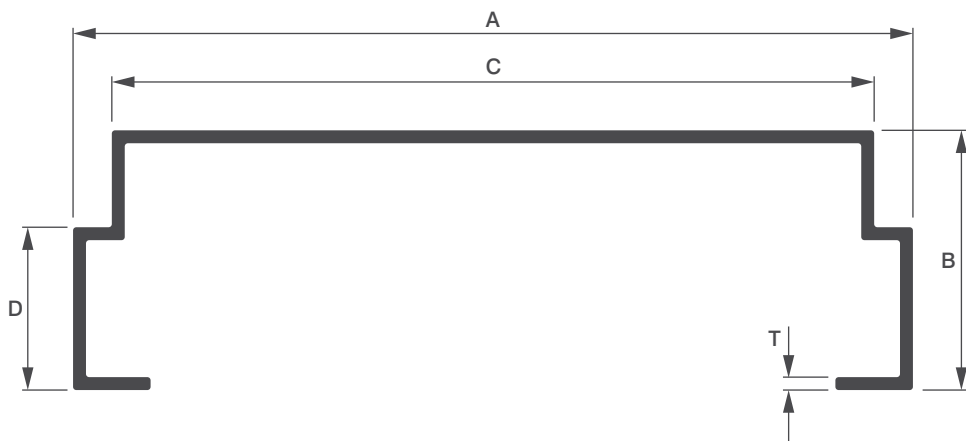

Sl. No.	Sec. No.	A	B	C	D	T	Wt. Range KG/12'
1	1647	130.00	40.20	118.00	25.20	2.00	4.400 - 4.800

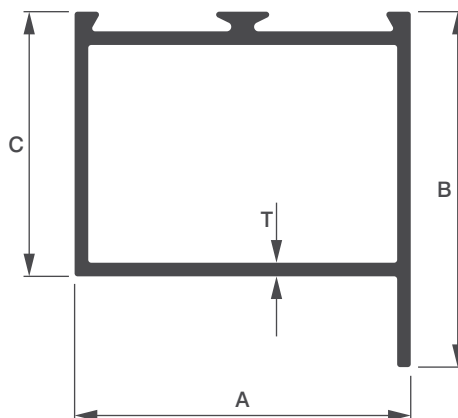

Sl. No.	Sec. No.	A	B	C	T	Wt. Range KG/12'
1	1738	44.45	47.00	35.00	1.80	3.000 - 3.300



PARTITION & DOORS

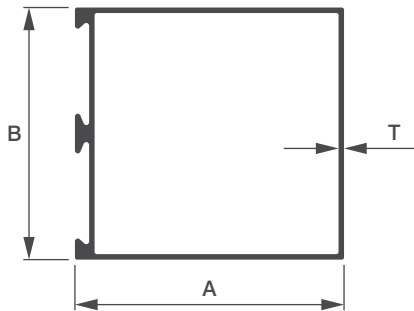

Sl. No.	Sec. No.	A	B	T	Wt. Range KG/12'
1	1701/L	47.50	44.50	1.25	2.000 - 2.400
2	1701	47.50	44.50	1.45	2.700 - 3.100
3	1702	47.50	44.50	2.40	4.300 - 4.800
4	1741	47.50	44.50	1.95	3.500 - 4.000
5	1742	100.00	44.50	2.00	5.600 - 6.000

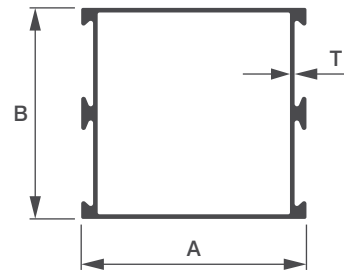

Sl. No.	Sec. No.	A	B	T	Wt. Range KG/12'
1	1703/L	47.50	44.50	1.20	2.000 - 2.400
2	1703	47.50	44.50	1.40	2.700 - 3.100
3	1704	47.50	44.50	2.00	3.900 - 4.300
4	1743	47.50	44.50	2.45	4.800 - 5.300
5	1749	100.00	44.50	1.25	3.950 - 4.400

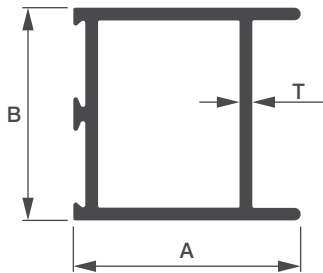

Sl. No.	Sec. No.	A	B	T	Wt. Range KG/12'
1	1705/L	47.50	44.50	1.20	2.000 - 2.400
2	1705	47.50	44.50	1.40	2.700 - 3.100
3	1706	47.50	44.50	1.95	3.750 - 4.200
4	1745	47.50	44.50	2.50	4.750 - 5.250

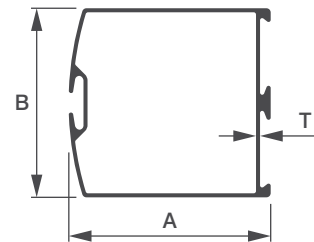

Sl. No.	Sec. No.	A	B	T	Wt. Range KG/12'
1	1712/L	47.50	44.50	0.95	1.900 - 2.200
2	1712	47.50	44.50	1.05	2.400 - 2.800
3	1713	47.50	44.50	1.40	3.200 - 3.600
4	1714	47.50	44.50	1.75	3.900 - 4.400
5	1715	47.50	44.50	2.40	5.200 - 5.600
6	1717	85.00	44.50	2.00	5.300 - 5.800
7	1747	85.00	44.50	2.50	6.300 - 6.800
8	1748	100.00	44.50	2.00	6.300 - 6.700

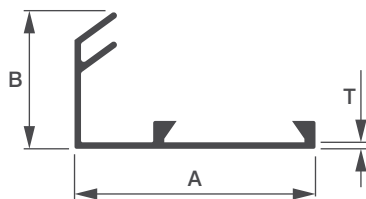

Sl. No.	Sec. No.	A	B	T	Wt. Range KG/12'
1	1726/L	31.20	17.70	0.65	0.500 - 0.580
2	1726	31.20	17.70	0.80	0.600 - 0.650

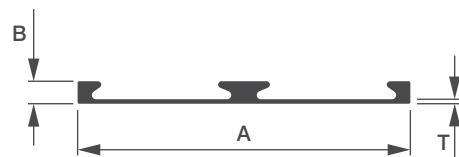

Sl. No.	Sec. No.	A	B	T	Wt. Range KG/12'
1	1724	44.00	3.00	0.58	0.490 - 0.540



PARTITION & DOORS

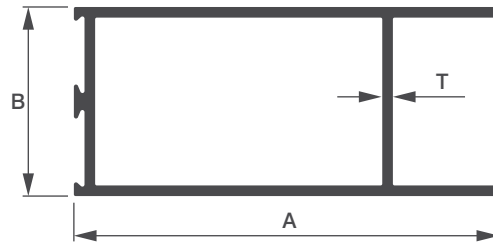

Sl. No.	Sec. No.	A	B	T	Wt. Range KG/12'
1	1707	95.00	44.50	1.00	2.800 - 3.200
2	1708	100.00	44.50	1.25	3.700 - 4.200
3	1709	100.00	44.50	2.00	5.500 - 6.200
4	1710	100.00	44.50	2.45	7.100 - 7.800
5	1711/L	100.00	44.50	2.70	7.600 - 8.200
6	1711	100.00	44.50	2.90	8.300 - 8.800
7	1718	114.00	44.50	1.40	4.500 - 5.100
8	1719	114.00	44.50	2.25	7.100 - 7.600
9	1720	150.00	44.50	2.00	8.000 - 8.600

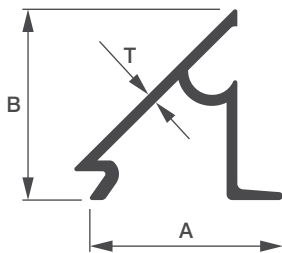

Sl. No.	Sec. No.	A	B	T	Wt. Range KG/12'
1	1721/L	19.00	17.50	0.35	0.200 - 0.240
2	1721	19.00	17.50	0.40	0.250 - 0.280
3	1722	18.40	17.10	0.65	0.330 - 0.380
4	1723	18.40	17.10	0.85	0.400 - 0.450
5	1725	19.50	18.30	1.20	0.570 - 0.620

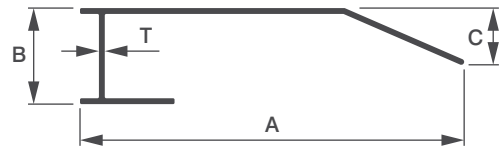

Sl. No.	Sec. No.	A	B	C	T	Wt. Range KG/12'
1	1733	101.60	25.40	15.00	1.55	2.400 - 2.800

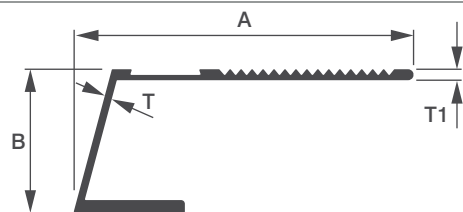

Sl. No.	Sec. No.	A	B	T	T1	Wt. Range KG/12'
1	1734	89.84	38.00	2.50	2.90	3.300 - 3.600

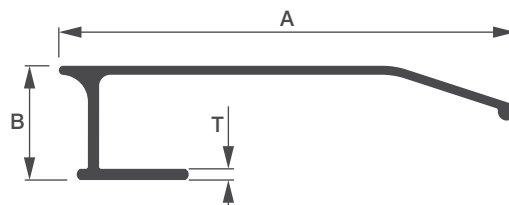

Sl. No.	Sec. No.	A	B	T	Wt. Range KG/12'
1	1753	102.00	25.50	2.00	3.300 - 3.650



PARTITION & DOORS

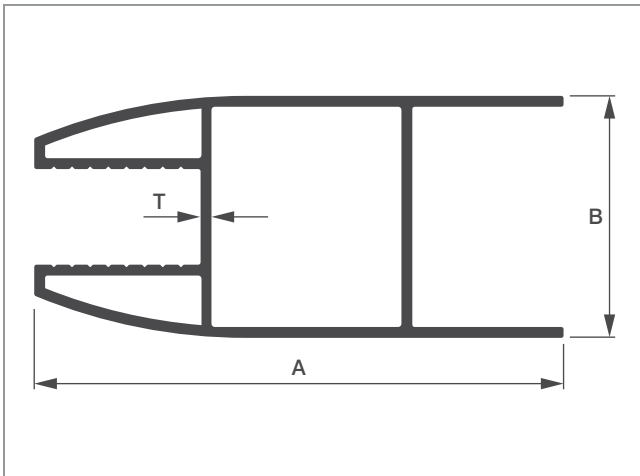

Sl. No.	Sec. No.	A	B	T	Wt. Range KG/12'
1	1762	87.50	32.00	1.80	6.700 - 7.100

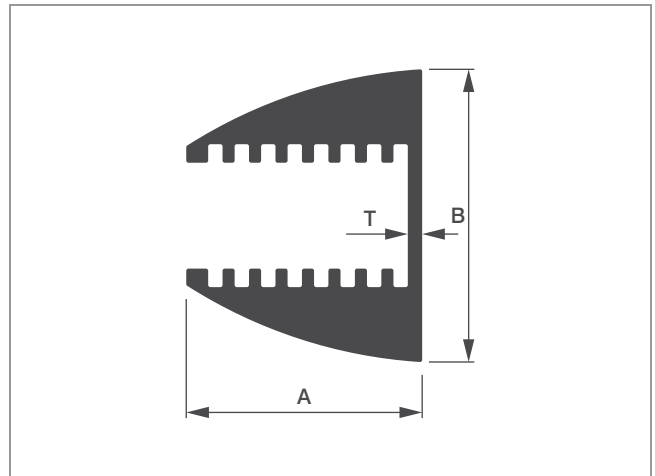

Sl. No.	Sec. No.	A	B	T	Wt. Range KG/12'
1	1763	31.20	38.70	1.90	4.900 - 5.400

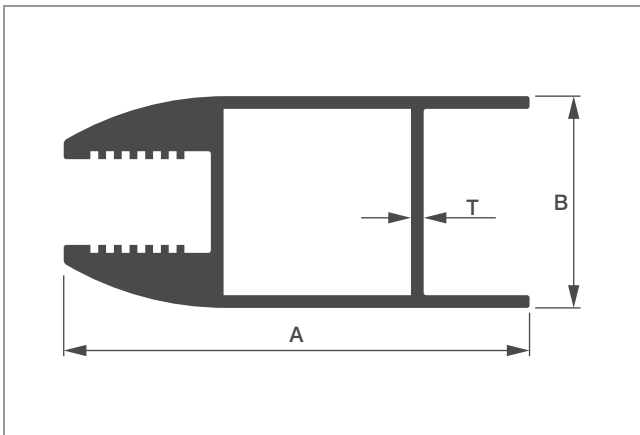

Sl. No.	Sec. No.	A	B	T	Wt. Range KG/12'
1	1761/L	88.00	40.00	2.00	8.000 - 8.500
2	1761	88.00	40.00	2.40	9.000 - 9.700

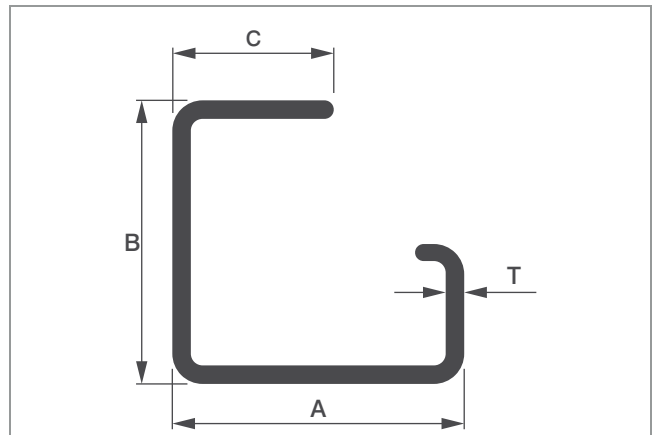

Sl. No.	Sec. No.	A	B	C	T	Wt. Range KG/12'
1	1751	38.60	37.50	21.35	2.45	2.600 - 2.850

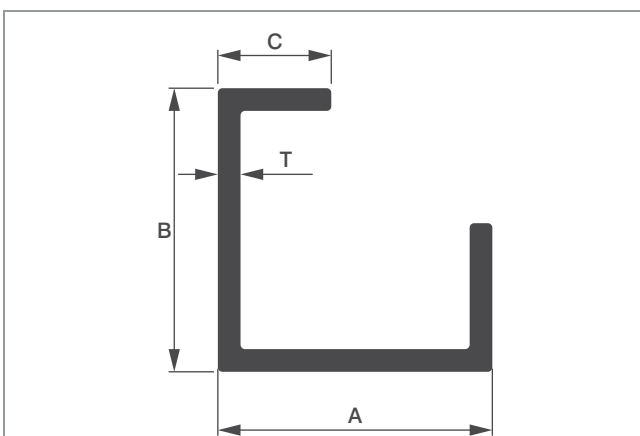

Sl. No.	Sec. No.	A	B	C	T	Wt. Range KG/12'
1	4178	24.20	25.00	10.00	2.00	1.350 - 1.650

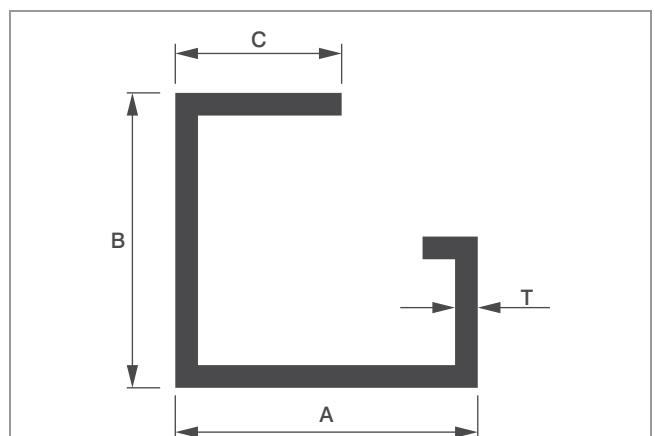

Sl. No.	Sec. No.	A	B	C	T	Wt. Range KG/12'
1	7377	40.00	39.00	22.00	3.00	3.400 - 3.700



PARTITION & DOORS

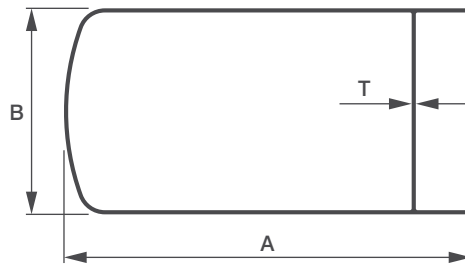

Sl. No.	Sec. No.	A	B	T	Wt. Range KG/12'
1	1731	88.00	44.50	0.90	2.200 - 2.600

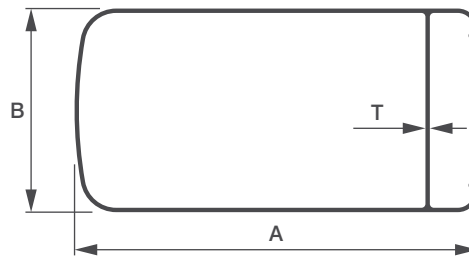

Sl. No.	Sec. No.	A	B	T	Wt. Range KG/12'
1	1732	101.60	50.80	1.10	3.000 - 3.600

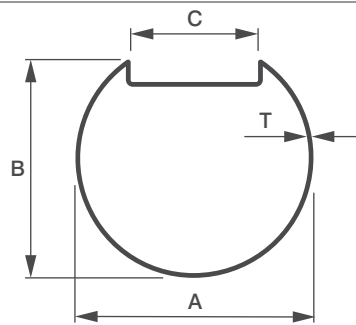

Sl. No.	Sec. No.	A	B	C	T	Wt. Range KG/12'
1	1735	60.00	54.80	32.00	1.20	2.250 - 2.600

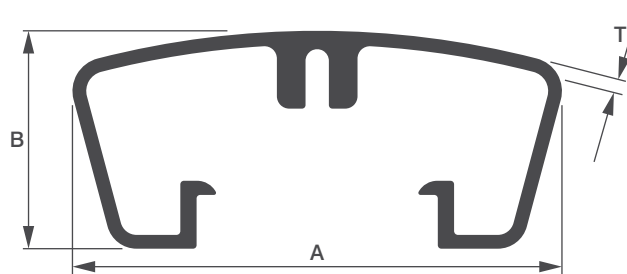

Sl. No.	Sec. No.	A	B	T	Wt. Range KG/12'
1	1736	65.00	31.00	1.40	2.400 - 2.800
2	1737	69.20	30.80	2.00	3.850 - 4.250