

KITCHEN SECTIONS

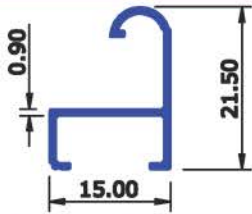

SEC No : 4209 WEIGHT Kg/Mtr 0.134

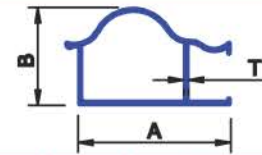

SL No.	SECTION No.	A	B	T	WEIGHT KG/Mtr
1	7965	36.00	23.00	0.70	0.204
2	4210	36.00	23.00	0.85	0.245

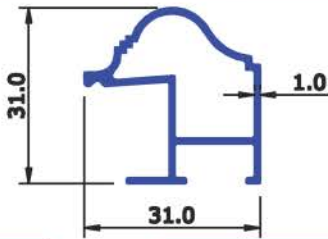

SEC No : 4211 WEIGHT Kg/Mtr 0.186

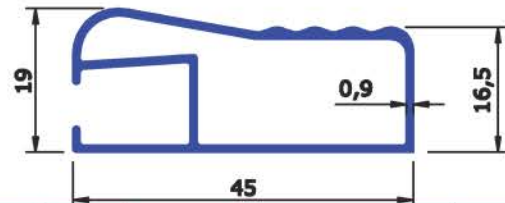

SEC No : 4212 WEIGHT Kg/Mtr 0.359

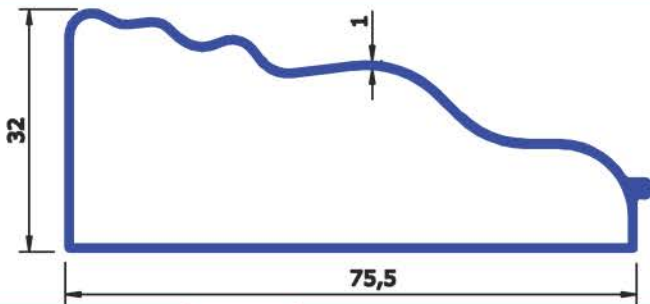

SEC No : 4223 WEIGHT Kg/Mtr 0.546

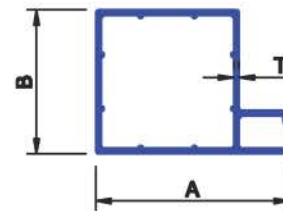

SL No.	SECTION No.	A	B	T	WEIGHT KG/Mtr
1	4262	34.10	25.30	1.00	0.245
2	7944	34.10	25.30	1.20	0.327

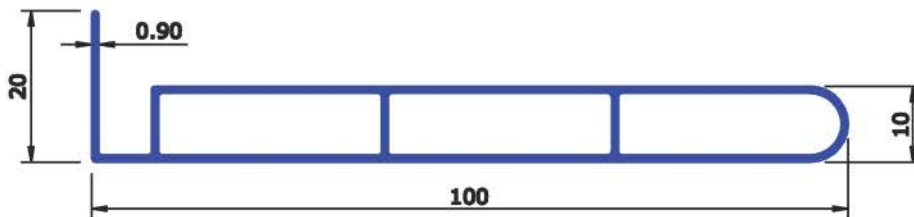

SECTION No : 4261 WEIGHT Kg/Mtr 0.573

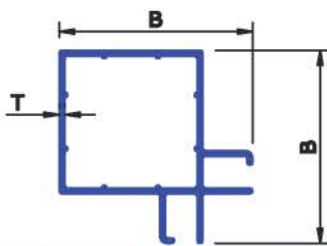

SL No.	SECTION No.	A	B	T	WEIGHT KG/Mtr
1	4263	34.10	34.10	1.00	0.245
2	7945	34.10	34.10	1.20	0.341

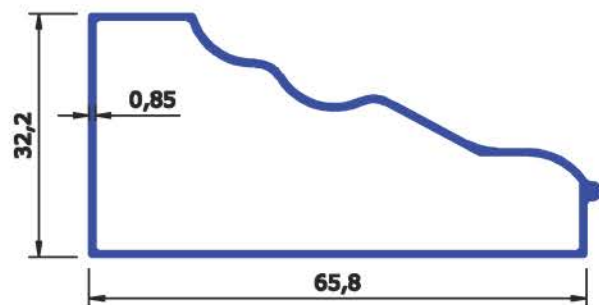

SEC No : 4286 WEIGHT Kg/Mtr 0.423

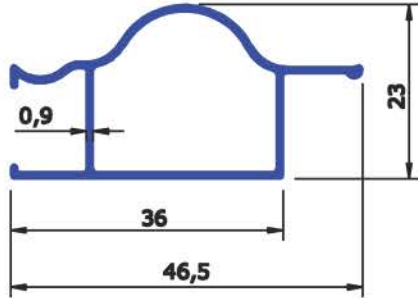

SEC No : 4287 WEIGHT Kg/Mtr 0.292

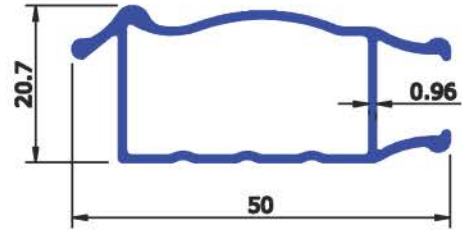

SEC No : 4652 WEIGHT Kg/Mtr 0.388

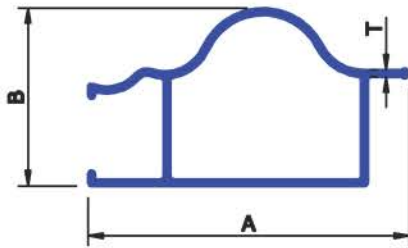

SL. No.	SECTION No.	A	B	T	WEIGHT KG/Mtr
1	7947	42.50	23.50	0.70	0.204
2	7948	42.50	23.50	0.80	0.232
3	4719	42.50	23.50	0.90	0.273

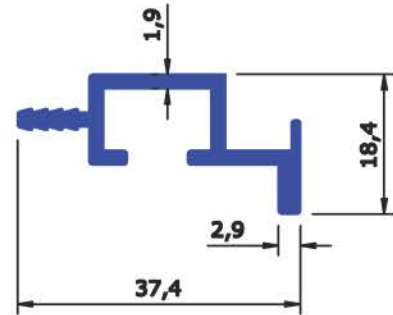

SEC No : 7476 WEIGHT Kg/Mtr 0.396

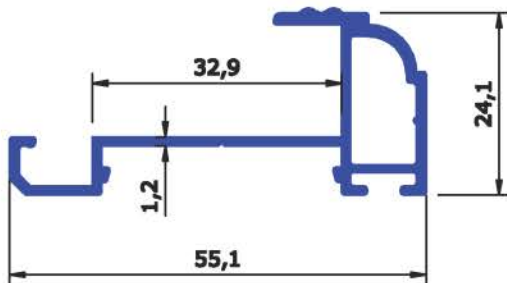

SEC No : 4784 WEIGHT Kg/Mtr 0.475

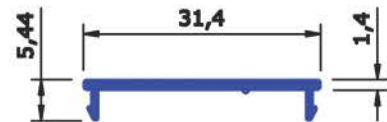

SEC No : 4785 WEIGHT Kg/Mtr 0.142

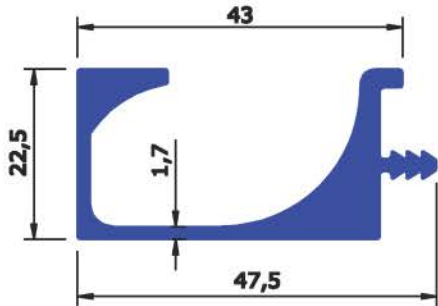

SEC No : 4569 WEIGHT Kg/Mtr 0.808

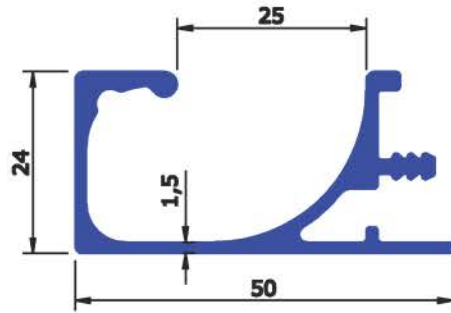

SEC No : 6566 WEIGHT Kg/Mtr 0.659

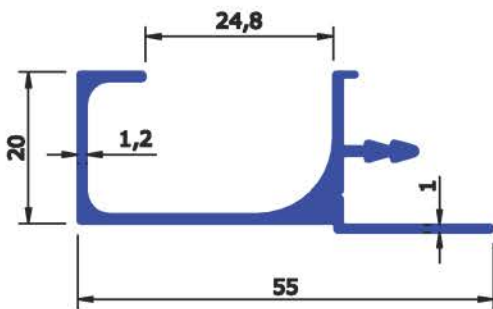

SEC No : 6570 WEIGHT Kg/Mtr 0.435

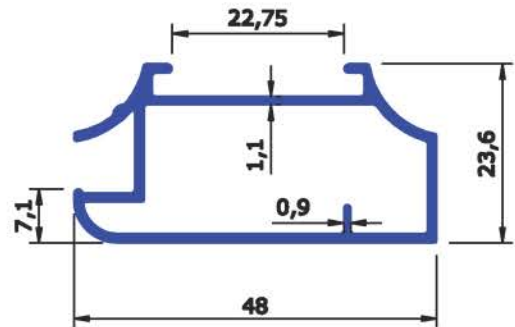

SEC No : 7909 WEIGHT Kg/Mtr 0.491

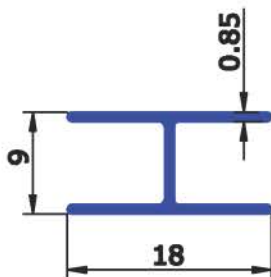

SEC No : 5409 WEIGHT Kg/Mtr 0.222

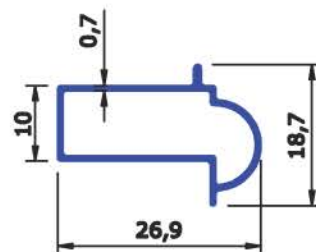

SEC No : 7911 WEIGHT Kg/Mtr 0.151

KITCHEN SECTIONS

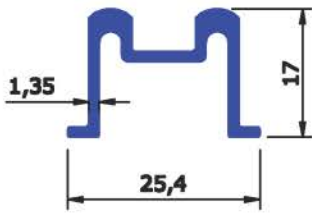

SEC No: 5801 WEIGHT KG/Mtr 0.267

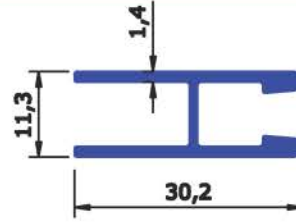

SEC No: 5802 WEIGHT KG/Mtr 0.285

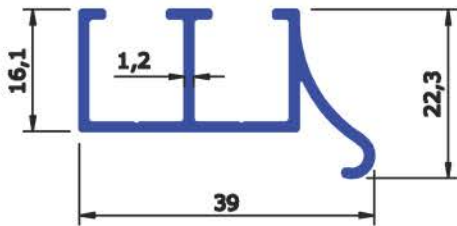

SEC No: 5803 WEIGHT KG/Mtr 0.338

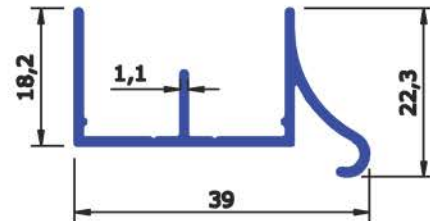

SEC No: 5804 WEIGHT KG/Mtr 0.278

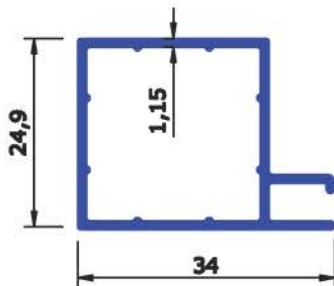

SEC No: 5823 WEIGHT KG/Mtr 0.365

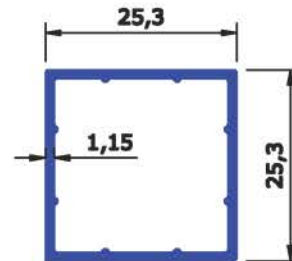

SEC No: 5824 WEIGHT KG/Mtr 0.308

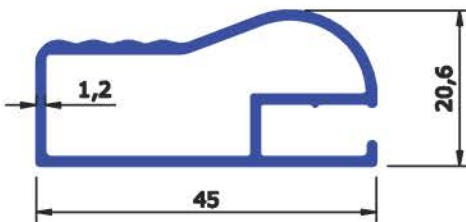

SEC No: 5825 WEIGHT KG/Mtr 0.451

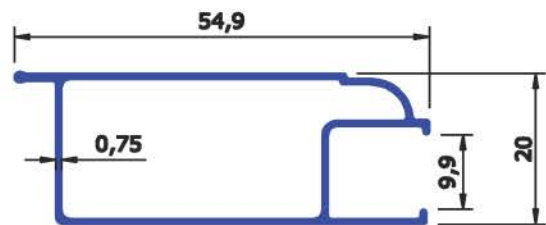

SEC No: 7930 WEIGHT KG/Mtr 0.314